

TEPEX d.o.o. 10090 Zagreb, Medarska 69 tel. +38549222900 fax +38549426450 e-mail: tepex@tepex.hr	USER MANUAL FOR EXPLOSION PROTECTED GROUNDING AND GROUNDING CONTROL DEVICE type GGCD-01/..		
	No: TEPEX.RS.040	Rev : 6	Date: 02.2023.

CONTENTS

1.	Manufacturer	1
2.	General safety information's	1
3.	Purpose	2
4.	Degree of protection	2
5.	Technical data	2
6.	Model code	3
7.	Operating principle	3
8.	Flow diagram	5
9.	Block sheme	6
10.	Installing, control, maintenance and repair	6
11.	Dimension and mounting	8
12.	Spare parts and accessories	8
13.	Responsibility and authorization	9
14.	Storage and transport	9
15.	Manufacturer's warranty	9
16.	Marking	9

1. MANUFACTURER

TEP Ex d.o.o. , Medarska 69, HR-10090 Zagreb
T 00385 49 222900, F 00385 49 426450
e-mail: tepex@tepex.hr, www.tepex.hr

2. GENERAL SAFETY INFORMATIONS



WARNING!

The user manual contains basic information about the product. Mounting, installation, usage and maintenance should be carried out under this user manual to provide and ensure safe operation within the nominal characteristics. This user manual complement national Regulation and Standards. The responsible person shall ensure their implementation. Failure off implement this user manual can reduce explosion protection and endanger people, property and the environment. Any improper and illegal actions as well as non-compliance with the provisions of this user manual excludes all responsibility by manufacturer side.

Before installation/commissioning:

- Carefully read all instructions,
- Execute proper training of responsible personnel,
- Check that the contents of these instructions is fully understandable by the responsible personnel,
- Make sure that all the requirements and national Regulations as well as all special security measures are applied.

In lack of understanding:

- Contact the manufacturer.

During operation:

- Ensure that this user manual and other work instructions are available to the responsible staff at all times,
- Check the implementation of these instructions and all other safety user's instructions.

3. PURPOSE

GGCD 01 device (Grounding and grounding control device) along with the grounding clamps makes the active system for static grounding and grounding control and it is used in areas where an explosive gas and/or dust atmosphere may be present, respectively in hazardous areas 1, 2, 21, 22 in accordance with the standards EN 60079-10-1 and EN 60079-10-2. Device ensures that objects like tanks are electrostatic grounded correctly during the loading and unloading of flammable liquids. The device provides a conductive connection to the earth and monitors in parallel the quality of the connection. The electrostatic level of the tank is kept on a safe level. An occasional discharge in conjunction with sparks is prevented and therefore the explosion protection ensured.

4. DEGREE OF PROTECTION

The device complies with standards EN 60439-1, EN 60947-1, EN 60947-3, EN 60947-5-1, EN 60598-1 and other related standards

The product complies with the standards:

- EN IEC 60079-0:2018,
- EN 60079-1:2014,
- EN IEC 60079-7:2015/A1:2018,
- EN 60079-11:2012,
- EN 60079-18:2015/A1:2017,
- EN 60079-31:2014.

The product has been developed, manufactured and tested according to the existing state of technique accordance with the standards EN ISO 9001, EN ISO 80079-34 and EN ISO 14001.



The product is in compliance with the ATEX Directive 2014/34/EU.

The product is in compliance with the LVD Directive 2014/35/EU.

The product is in compliance with the RoHS Directive 2011/65/EU.

The product is in compliance with the EMC Directive 2014/30/EU.

5. TECHNICAL DATA

Certificate:	FIDI 19 ATEX 0050
Category and explosion protection:	 0722  II 2G Ex db eb mb [ib] IIC T5 Gb II 2D Ex tb [ib] IIIC T80°C Db
Ambient temperature:	-20°C ≤ Ta ≤ +50°C
Mechanical protection:	IP 66, category 1
Class of protection:	I (PE – protective earthing)
Nominal voltage Un:	24 V ± 10 % DC 230 V ± 10 % AC, 50/60 Hz
Nominal current In:	150 mA na 24 V DC 18 mA na 230 V AC
Nominal power P0 :	4 VA na 230 V AC 3,5 W na 24 V DC
Output circuit:	2 switch over contacts Un=250 V AC, In=8 A / 230 V, 4 A at cos φ = 0,4
Bonding/earthing earth paths resistance:	10 Ω
Indicating lamps:	Red: - blinking inside control time (10 sec - MOD2), contacts NO are open, contacts NC are closed, - continuous operation (MOD1 and MOD 2), contacts NO are open, contacts NC are closed Green: - continuous operation (MOD1 and MOD 2), contacts NO are closed, contacts NC are open
Breaking capacity:	35 A
Max. r.m.s. voltage Um:	253 V
Max. open circuit voltage U0:	18,1 V
Max. current I0:	58,4 mA
Max. power P0:	0,27 W - linear characteristics
Max. external inductance L0:	10 mH
Max. external capacity C0:	266 nF
Length of the clamp cable:	10 m
Length of coiled cable on reel:	max. 50 m
Connecting terminals:	- network supply terminal, output contacts: 1,5-4 mm ² stranded, flexible - Cable to the grounding point or busbar for equipotential bonding: 6-16 mm ² max. stranded, flexible
Stripping length:	4 mm ² - 10 mm, 16 mm ² - 14 mm
Tightening torque of terminal	terminal 4 mm ² - 0,6 Nm, terminal 16 mm ² - 3,0 Nm

screws:	
Cable ferrules:	Stranded and flexible cables are installed with cable ferrules according to DIN 46228 T1
Cover screws:	M6x30 (Z4) - 4,8 A2
Tightening torque for cover screw:	1,5 Nm
Cable glands and plugs:	- GGCD 01/K1: 3 x M25 Ex i cable glands and 2 x M25 Ex eb cable glands for cable $15 > \varnothing_v > 7$ mm, 1 x M25 Ex i plug, 1 x M25 Ex eb plug - GGCD 01/K2 - 4 x M25 Ex i cable glands, 2 x M25 Ex eb cable glands for cable $15 > \varnothing_v > 7$ mm, 1 x M25 Ex eb plug
Tightening torque for cable glands:	- cable gland body 3,5 Nm, - cable gland nut 2,5 Nm
Tightening torque for plugs:	3,5 Nm
Clamp cable:	Lapp Olflex EB 3 or 2 x 1,5 mm ² - cable capacity (wire-wire) 140 nF/km - wire inductance 0,52 mH/km - wire resistance 13,7 Ω /km
Coiled cable on reel:	Lapp Olflex EB 3 x 1,5 mm ² - cable capacity (wire-wire) 140 nF/km - wire inductance 0,52 mH/km - wire resistance 13,7 Ω /km ili Helukabel OZ-BL 3 x 2,5mm ² - cable capacity (wire-wire) 120 nF/km - wire inductance 0,68 mH/km - wire resistance 8,21 Ω /km
Dimension (LxWxH):	250 x 300 x 120 mm without clamps
Dimension of clamps holder(L x W x H):	410 x 320 x 20 mm without clamps
Mounting enclosure onto surface:	With screw kit M6 through the holes in the enclosure $\varnothing 7/\varnothing 12$ mm at the top of the rectangle 280 x 200 mm
Mounting clamps holder onto surface:	With screw kit M8 at the top of the rectangle 295 x 230 mm
Weight (without clamps):	ca. 6,0 kg
Weight of clamps with 10 m cable:	ca. 2,5 kg

6. MODEL CODE

GGCD 01 / . . . - .	basic device marking
- K1	- type with one clamp K1, with 10m cable,
- K2	- type with two clamps K2, with 2 x 10m cable.
	nominal voltage:
-1	- 24 V \pm 10 % DC
-2	- 230 V \pm 10 % AC

7. OPERATING PRINCIPLE

Each version of GGCD device has two operating modes (which can be selected with control switch):

MOD 1 - in the presence of mains supply at the time of connection of the clamps to the earthing object, the device recognizes total earthing resistance, i.e. is the resistance between the earthing object and the grounding less than 10 Ω .

The total ground resistance of R_{ZUK} is the replacement resistance of the combination $R_Z + R_{C1} + R_{C2} + R_{PAL1} + R_{PAL2}$.

If $R_{ZUK} < 10 \Omega$ object is considered to be electrostatically grounded.

It is used when the earthing object cannot be isolated from the ground in a controlled manner (e.g. rail vehicles, underground reservoirs, etc.).

MOD 2 - in the presence of mains supply within the control time of approx. 10 s after activating the START button, the device recognizes whether the earthing object is already earthed in another uncontrolled manner with $R_Z < 5 \Omega$ and device recognizes total earthing resistance, i.e. is the resistance between the earthing object and the grounding is less than 10 Ω .

The total earthing resistance of R_{ZUK} is the replacement resistance of the combination $R_Z + R_{C1} + R_{C2} + R_{PAL1} + R_{PAL2}$.

If $R_{ZUK} < 10 \Omega$ object is considered to be electrostatically grounded.

It is used when the earthing object is insulated from the ground in a controlled way (e.g. tank trucks, etc.).

Symbol	ENG
R_{c1}, R_{c2}	Contact resistance at the connection point of pliers-object connection
R_Z	The current resistance of the grounding object to the earth (before connecting the GGCD)
R_{PAL1} R_{PAL2}	Resistance of the conductor from GGCD to the connection point on the grounding point
R_{ZUK}	Total grounding resistance

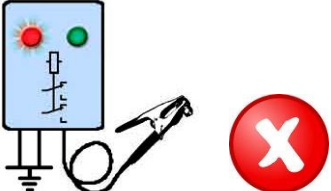
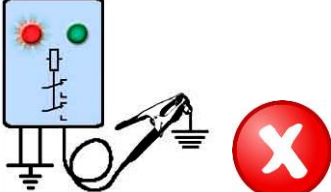
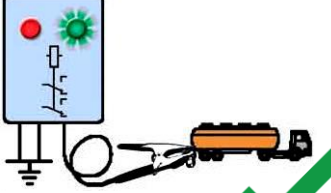
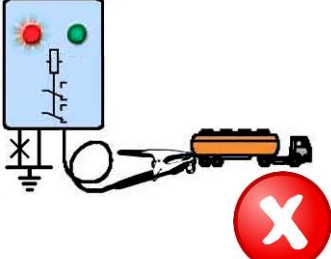
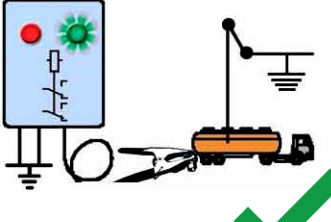
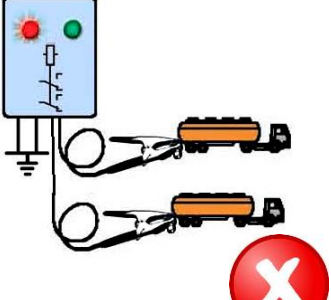
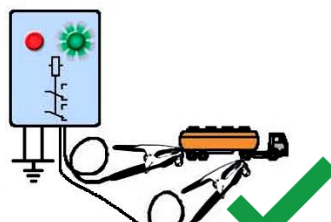
State of earthing process		Reaction of the earthing monitoring device
	<p>GGCD 01/K1 is not correct connected and turned ON. Clamp is not connected, grounding equipment not in use</p>	<p>Earthing incorrect</p> <ul style="list-style-type: none"> • Red indicating lamp ON • Green indicating lamp OFF • Contact OPEN
	<p>GGCD 01/K1 is correct connected and turned ON, but clamp is directly grounded, e.g. via the loading platform</p>	<p>Earthing incorrect (only MOD 2)</p> <ul style="list-style-type: none"> • Red indicating lamp ON • Green indicating lamp OFF • Contacts OPEN
	<p>GGCD 01/K1 is correct connected and turned ON. Clamp connected to tank vehicle.</p>	<p>Earthing OK</p> <ul style="list-style-type: none"> • Red indicating lamp OFF • Green indicating lamp ON • Contacts CLOSED
	<p>GGCD 01/K1 is correct connected and turned ON, but cable to the grounding is disconnected.</p>	<p>Earthing incorrect</p> <ul style="list-style-type: none"> • Red indicating lamp ON • Green indicating lamp OFF • Contacts OPEN
	<p>GGCD 01/K1 is correct connected and turned ON. Clamp connected to tank vehicle. Tank vehicle is grounded subsequently (e.g. via the loading arm).</p>	<p>Earthing OK</p> <ul style="list-style-type: none"> • Red indicating lamp OFF • Green indicating lamp ON • Contacts CLOSED
	<p>GGCD 01/K2 is correct connected and turned ON. Two clamps are connected on two separate object grounding.</p>	<p>Earthing incorrect</p> <ul style="list-style-type: none"> • Red indicating lamp ON • Green indicating lamp OFF • Contacts OPEN
	<p>GGCD 01/K2 is correct connected and turned ON. Two clamps are connected on one object grounding.</p>	<p>Earthing OK</p> <ul style="list-style-type: none"> • Red indicating lamp OFF • Green indicating lamp ON • Contacts CLOSED

8. FLOW DIAGRAM

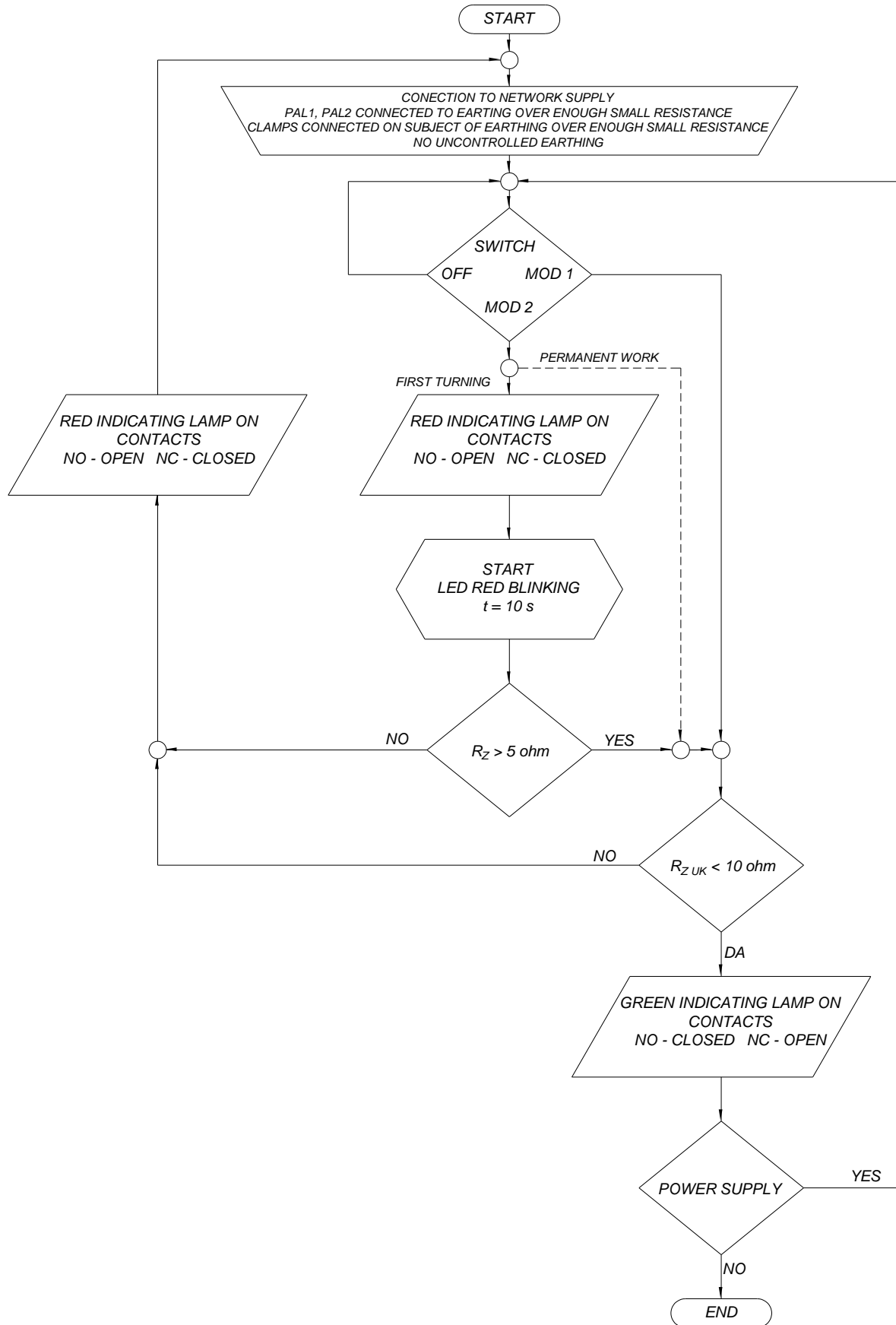

9. BLOCK SCHEME

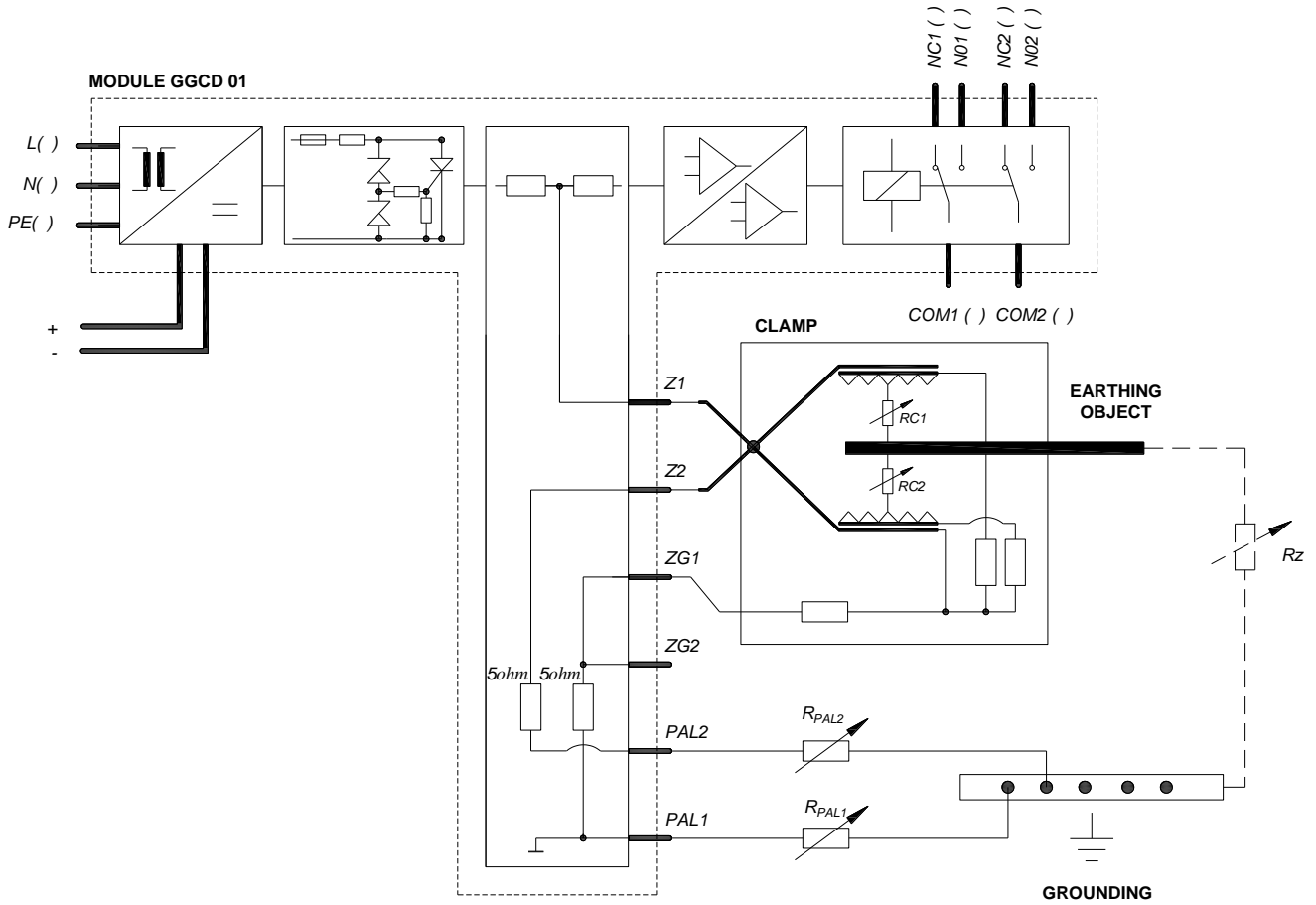

10. INSTALLING, CONTROL, MAINTENANCE AND REPAIR

It is necessary to read this manual before installing and usage and if it is needed to request extra informations from manufacturer. Installing and usage of device is allowed only to qualified and authorized persons. Installing of device have to be done in non-voltage state. PAL (equipotential bonding connection) terminals inside device are connected to PA (equipotential bonding connection) busbar or grounding point with two single wire cables. In that case control loop is achieved and permanent monitoring of galvanic continuity connection PAL (equipotential bonding connection) terminal with PA (equipotential bonding connection) busbar or grounding point. Connection is made with conductor with cross-section 6-16 mm².

Electric connection, and cables for output connections inside enclosure must be conducted separately from intrinsic safety conduits. It is not allowed to connect output connectors into other intrinsic safety circuits. Along whole area of grounding equipotential bonding (PA) must be done. At enclosure closing, cover screws, cable glands and plugs must be tightened with torque specified in this manual.

Every afterwards enclosure opening is allowed only when supply is switched off.

Before connecting earthing clamps on the object, object itself must be electrostatically discharged which must be secured in appropriate way.

Electric connection scheme of cables and conductors:

TOP view without built-in components

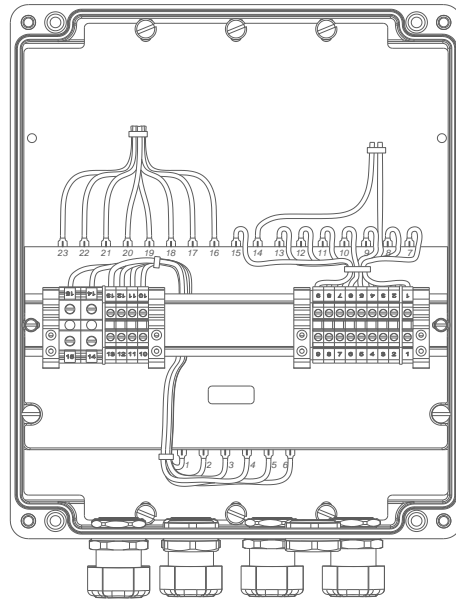

Terminals	RELAY OUTPUT 1	RELAY OUTPUT 2	RELAY OUTPUT 3	RELAY OUTPUT 4	RELAY OUTPUT 5	RELAY OUTPUT 6	POWER SUPPLY
4	NC1						GND
5	COM1						L
6	NO1						N
7	NO2						NC2
8	COM2						NC2
9							RELAY OUTPUT 1
10							RELAY OUTPUT 2
11							RELAY OUTPUT 3
12							RELAY OUTPUT 4
13							RELAY OUTPUT 5
14							RELAY OUTPUT 6
15							

GGCD 01/K2

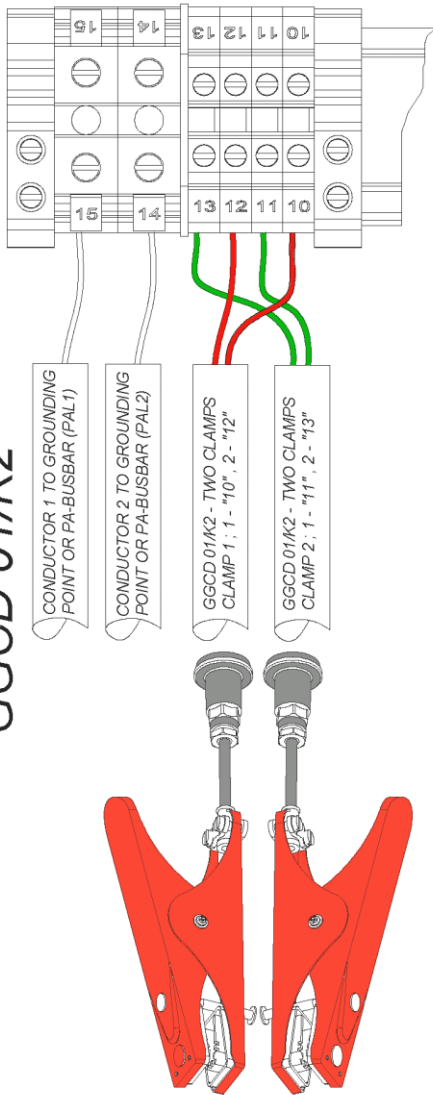

GGCD 01/K1

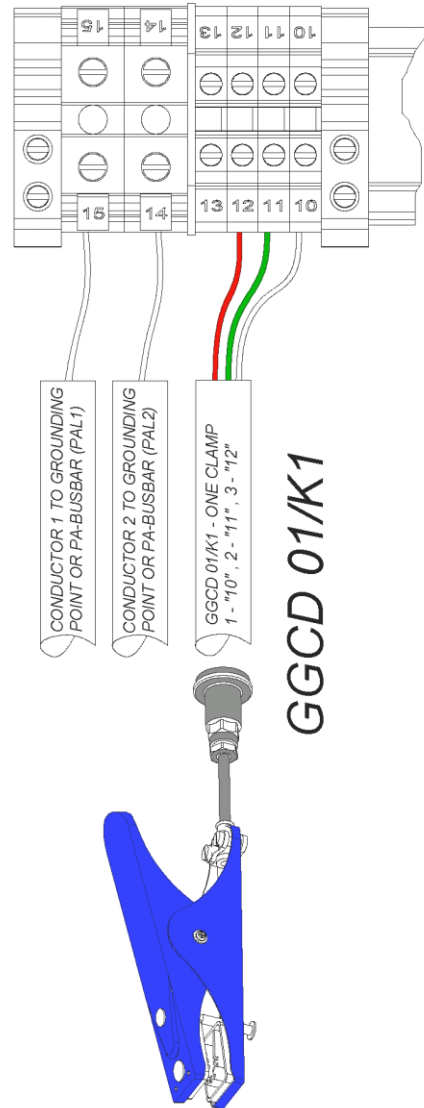

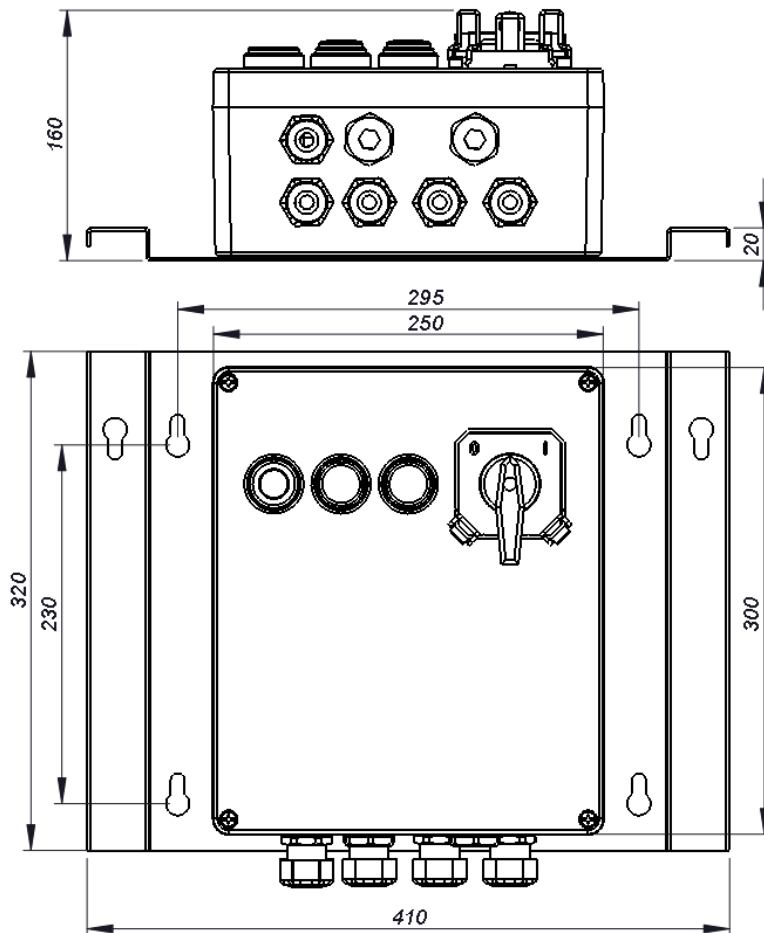

11. DIMENSIONS AND MOUNTING

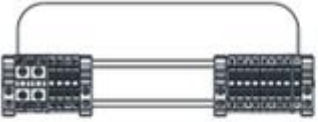
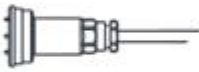

12. SPARE PARTS AND ACCESSORIES

Spare parts

SKETCH	DESCRIPTION	CODE
	Control module GGCD 01	GGCD 01 10-110
	Connecting cable 0,5m with coupler GGCD 01/K1	GGCD 01 10-120
	Connecting cable 0,5m with coupler GGCD 01/K2	GGCD 01 10-130
	Clamp K1 with 10m cable and plug	GGCD 01 10-140
	Clamp K2 with 10m cable and plug	GGCD 01 10-150
	Cable storage box	GGCD 01 10-160

- Pushbutton PBT 02,
- Signal lamp SLP,
- Switch SMS 03/GGCD,
- Pushbutton actuator SPO 01/7,
- Front element of signal lamp SPO 02/1,
- Front element of signal lamp SPO 02/2,

- Switch actuator SMO 17/GGCD
- Terminal 4mm², grey, CTS4UN
- Terminal 4mm², blue, CTS4UNBU
- Terminal 4mm², yellow-green, CTS4UNGN
- Terminal 16mm², yellow-green, CTS16UNGN
- Cable gland SPU 25 black,
- Cable gland SPU 25 blue,
- Plug SPC 25 black,
- Plug SPC 25 blue,
- Enclosure gasket MMK 17,
- Enclosure screws MMK 17, M6x30 (Z4) - 4,8 A2

Accessories

- Cable gland for armoured cable type Ex eb II, type SIB-DEF 4F, $9 < \varnothing_v < 27,5$ mm, $6 < \varnothing_u < 19,5$ mm, $f = 1,25 - 16$ mm, LCIE 05 ATEX 6146 X

13. RESPONSIBILITY AND AUTHORIZATION

This instruction is the basic information about the product. It is completed by the corresponding national laws and regulations.

Production, use, certification and supervision are determined at the national level:

- Regulations concerning equipment and protective systems intended for use in potentially explosive atmospheres EU directive 2014/34/EU and
- Regulations on minimum requirements for safety and health protection of workers and technical inspection of facilities, equipment, installations and equipment in hazardous areas EU directive 1999/92/EC (ATEX 137).

The responsible person shall ensure their implementation at the working facility.

14. STORAGE AND TRANSPORT

Transportation and warehousing of the lamps is only allowed in the original packaging, as outlined in a cardboard box.

15. MANUFACTURER'S WARRANTY

The manufacturer gives guarantee on the product for a period of one year under the provisions of the Law on Obligations. This statement has the force of the guarantee list.

16. MARKING

Explosion protected grounding and grounding control device type GGCD 01/K1, K2 is marked with internal and external labels:

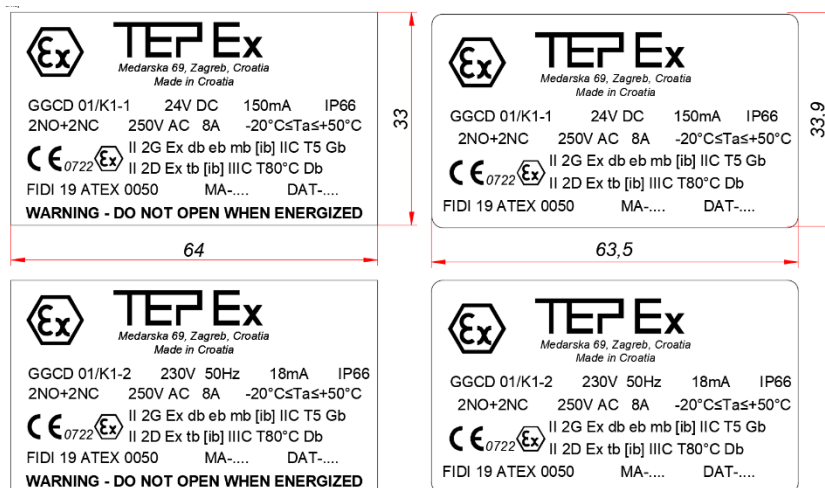

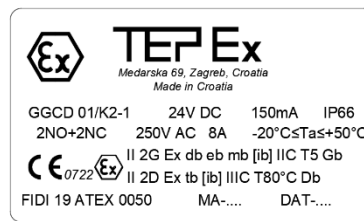

Cable with connector for GGCD 01/K1, GGCD 01/K2 is marked:



Clamps K1, K2 for GGCD 01/K1, GGCD 01/K2 are marked:



Module GGCD 01 is marked:

