



GIOVENZANA INTERNATIONAL B.V.

GIOVENZANA INTERNATIONAL B.V.

1077 XX Amsterdam, The Netherlands
WTC Strawinskylaan 1105

Phone: +31(0) 20.4413576 - Fax: +31(0) 20.4413456
E-mail: giovenzana@giovenzana.com

G.T.R. LLC

127051, Moscow, Russian Federation
Likhov lane, 3, b.2, office 101

Phone: +7.495.6991296 / +7.499.9228548 - Fax +7.495.6991520
E-mail: gtr@giovenzana.com

GIOVENZANA CONTROLS INDIA Pvt. Ltd.

400064, Near Mindspace, Malad West, Mumbai
A-203, Knox Plaza, Chincholi, Off Link Road

Phone: +91.22.42640071
E-mail: ggindia@giovenzana.com

GIOVENZANA do Brasil

São Paulo, Brasil
Rua Enxovia, 472 cj1904
Cep. 04711-030; Vila São Francisco
Phone: +55.11.3360-6840 / 11.3530-5316
E-mail: logistic.brasil@giovenzana.com

Branch DUBAI

DUBAI U.A.E. P.O. Box 262146 - Jebel Ali Free Zone
Phone: +971.4.8870788 - Fax: +971.4.8870787
E-mail: uae@giovenzana.com



www.giovenzana.com

AUTOMATION • AUXILIARY CONTROLS

GIOVENZANA INTERNATIONAL B.V.



AUXILIARY CONTROLS • POTENTIOMETERS
DOUBLE SOCKETS • FOOT SWITCHES





**QUALITY
AS A LIFE
STYLE**



www.giovenzana.com

GENERAL INDEX

2 AUTOMATION TECHNOLOGIES

CONTROL AUXILIARIES

5	PEGASUS SERIES BLACK LINE	29	ORION SERIES BLACK LINE · IP65	43	NEMA SERIES 4 - 4X
6	PUSH BUTTONS ø22 with colour caps	30	PUSH BUTTONS ø22 with colour caps	44	PUSH BUTTONS ø22 with colour caps
7	PUSH BUTTONS ø22 with lens cap	30	PUSH BUTTONS ø22 with lens cap	44	PUSH BUTTONS ø22 with lens cap
8	LED PILOT LIGHTS ø22	31	MULTIFUNCTION PUSH BUTTONS ø22	45	MULTIFUNCTION PUSH BUTTONS ø22
9	MULTIFUNCTION PUSH BUTTONS ø22	32	ROTARY SWITCHES ø22	46	EMERGENCY PUSH BUTTONS ø30 - ø40
10	ROTARY SWITCHES ø22	33	OPERATORS CAPS ø22	48	ROTARY SWITCHES ø22
11	JOYSTICK OPERATORS ø22		ORION SERIES GREY LINE · IP67-IP69K	49	OPERATORS CAPS ø22
12	EMERGENCY PUSH BUTTONS ø22			50	NEMA ACCESSORIES
14	CONTACT BLOCKS	34	PUSH BUTTONS ø22 with colour caps	51	TECHNICAL DATA
17	CONTROL STATIONS with mushroom ø90	34	PUSH BUTTONS ø22 with lens cap	52	ASSEMBLY INSTRUCTIONS
18	PUSH BUTTON STATIONS	35	MULTIFUNCTION PUSH BUTTONS ø22	53	NOTES
20	PUSH BUTTON STATION ENCLOSURES	36	ROTARY SWITCHES ø22		
22	PEGASUS ACCESSORIES	37	OPERATORS CAPS ø22		
23	OPERATORS CAPS ø22	38	ORION ACCESSORIES		
24	TECHNICAL DATA	40	TECHNICAL DATA		
26	ASSEMBLY INSTRUCTIONS	41	ASSEMBLY INSTRUCTIONS		
27	NOTES				

POTENTIOMETERS & DOUBLE SOCKETS

56	POTENTIOMETERS	57	DOUBLE SOCKETS RJ45	DOUBLE SOCKETS USB
-----------	-----------------------	-----------	----------------------------	---------------------------

FOOT SWITCHES

59	FOOT SWITCHES SERIES
60	SAFETY FOOT SWITCHES
62	SINGLE FOOT SWITCHES
66	DOUBLE FOOT SWITCHES
68	FOOT SWITCHES EQUIPMENT
69	NOTES



AUTOMATION TECHNOLOGIES

AUTOMATION

The solutions offered by **Giovenzana** are the results of the detailed analysis of industrial electrical accessories requirements in conformity with all relevant international standards. The range includes:

- Cam switches Phoenix series from 12A to 200A;
- Switch disconnectors Regolus series from 32A to 160A;
- Auxiliary Controls Pegasus, Orion and NEMA series;
- Limit switches available in pre-wired and thermoplastic version;
- Foot switches and micro switches.

QUALITY

Giovenzana, leader in the elevator and lifting equipment field, has gained a prominent position in the automation sector with the launch of industrial control devices into the market. For many years, all commercial and industrial operations have been integrated within the **UNI EN ISO 9001:2008** quality system.

CSQ certificate N 9105. GIOV.

Quality system is the end users guarantee that all production stages are closely followed under strict control and adhere to the requirements set by the company both in terms of customer expectations and compliance to the relevant international standards as proved by the various certificates **Giovenzana** holds for its products.

By the **UNI EN ISO 14001:2004**, **Giovenzana** keeps up with new technologies in order to reduce raw materials consumption, energy and natural resources and to minimize waste and emissions. This reduces the environmental impact.

The certification CSQ N 9191. GIBV.

COMPLIANCE

All **Giovenzana** products are manufactured according to the most relevant Cee directives. **Giovenzana** certifies this compliance with a declaration of conformity.

CERTIFICATIONS

In order to reach its high quality level **Giovenzana's** products are tested by multiple third parties. In order to obtain the UL mark, **Giovenzana** submits their products to Underwriter Laboratories Inc., one of the most eminent independent certification companies in the World.

CEE DIRECTIVES

From January 1st, 1997 it is compulsory to CE mark all electromechanical products: this has been outlined by an important regulation: 2006/95/CE Low Voltage Directives.

CE MARK

European directives, applied to all national regulations, set the minimum requirements in term of safety of all electrical material sold within the EU.

Compliance to these requirements is certified by the manufacturer by the CE mark placed on the products.

STANDARDS

Giovenzana's products comply with both the European EN and the American UL standards. These regulations, such as CEI EN 60204-1 (CEI 44-5) with regards to the safety requirements of the electrical circuits on board industrial machinery, define the characteristics, performance and use of the products.

EN EUROPEAN STANDARDS

The EN European standards are originated from IEC International standards and are the result of the collaboration between CENELEC (European Committee for Electrotechnical Standardization) member countries.

These standards cover and eliminate existing national standards that may be contradictory and non-compliant.





GIOVENZANA
INTERNATIONAL B.V.



GIOVENZANA
INTERNATIONAL B.V.



AUXILIARY CONTROLS
PEGASUS SERIES

AUXILIARY CONTROLS | PEGASUS SERIES

AUXILIARY CONTROLS | PEGASUS SERIES

PUSH BUTTONS Ø22 | WITH COLOUR CAP

MOMENTARY

TYPE	COLOUR INDEX	CODE	WEIGHT grams	MIN. PACK QUANTITY	SIZES
FLUSH PUSH BUTTON	■	PPRN1	30	10	
	■	PPRN2	30	10	
	■	PPRN3	30	10	
	■	PPRN4	30	10	
	■	PPRN5	30	10	
	■	PPRN8	30	10	

TYPE	COLOUR INDEX	CODE	WEIGHT grams	MIN. PACK QUANTITY	SIZES
EXTENDED PUSH BUTTON	■	PPSN1	31	10	
	■	PPSN2	31	10	
	■	PPSN3	31	10	
	■	PPSN4	31	10	
	■	PPSN5	31	10	
	■	PPSN8	31	10	

LATCHED

TYPE	COLOUR INDEX	CODE	WEIGHT grams	MIN. PACK QUANTITY	SIZES
FLUSH PUSH BUTTON	■	PPPN1	32	10	
	■	PPPN2	32	10	
	■	PPPN3	32	10	
	■	PPPN4	32	10	
	■	PPPN5	32	10	
	■	PPPN8	32	10	

TYPE	COLOUR INDEX	CODE	WEIGHT grams	MIN. PACK QUANTITY	SIZES
MUSHROOM OPERATOR Ø40	■	PPFN1S4N	35	10	
	■	PPFN2S4N	35	10	
	■	PPFN3S4N	35	10	

PUSH BUTTONS Ø22 | WITH LENS CAP

MOMENTARY

TYPE	COLOUR INDEX	CODE	WEIGHT grams	MIN. PACK QUANTITY	SIZES
FLUSH PUSH BUTTON	■	PPRL1	30	10	
	■	PPRL2	30	10	
	■	PPRL3	30	10	
	■	PPRL4	30	10	
	■	PPRL5	30	10	

TYPE	COLOUR INDEX	CODE	WEIGHT grams	MIN. PACK QUANTITY	SIZES
EXTENDED PUSH BUTTON	■	PPSL1	31	10	
	■	PPSL2	31	10	
	■	PPSL3	31	10	
	■	PPSL4	31	10	
	■	PPSL5	31	10	

LATCHED

TYPE	COLOUR INDEX	CODE	WEIGHT grams	MIN. PACK QUANTITY	SIZES
FLUSH PUSH BUTTON	■	PPPL1	32	10	
	■	PPPL2	32	10	
	■	PPPL3	32	10	
	■	PPPL4	32	10	
	■	PPPL5	32	10	

IND. LIGHT

TYPE	COLOUR INDEX	CODE	WEIGHT grams	MIN. PACK QUANTITY	SIZES
FLAT CAP	■	PLSL1NL	30	10	
	■	PLSL2NL	30	10	
	■	PLSL3NL	30	10	
	■	PLSL4NL	30	10	
	■	PLSL5NL	30	10	

AUXILIARY CONTROLS | PEGASUS SERIES

AUXILIARY CONTROLS | PEGASUS SERIES

LED PILOT LIGHT Ø22

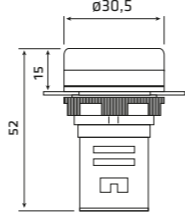
DESCRIPTION	POWER SUPPLY	CODE	WEIGHT gramm	MIN. PACK QUANTITY	SIZES
 SINGLE LED INDICATOR X1 — X2	AC/DC 6V 1	PLML 2 L6	15	10	
	AC/DC 12V 1	PLML 2 L12	15	10	
	AC/DC 24V	PLML 2 L24	15	10	
	AC/DC 48V	PLML 2 L48	15	10	
	AC/DC 110V	PLML 2 L110	15	10	
	AC/DC 220V	PLML 2 L220	15	10	
	AC 380V 1	PLML 2 L380	15	10	

COMPLY WITH RULES

EN60947-5-1 / GB14048.5

DIAGRAM

Operational temperature	°C	-5 +40
Operational umidity		45% ... 90%
AC rated frequency	Hz	50/60
Rated insulation voltage	1 min V	2500V
Over voltage category	EN60947.1	III
Pollution grade	EN60947.1	3
Protection degree	EN60529	IP65, IP2X terminals
Connection:		
Terminal block caliber		A2
Terminal screw		M3,5
Flexible and solid conductor section	min/max	n. 1 1/2,5 mm ² - n. 2 1/2,5 mm ²
Rated operational voltage Ue	AC/DC V	6, 12, 24, 48, 110, 220
	AC V	380
Rated operational voltage Ie	mA	≤80 6,12V
	mA	≤20 24, 48, 110, 220, 380V
Electrical life	h	≥30.000
Brightness	cd/m ²	100
Mounting	mm	Ø22,5

RESISTANCE

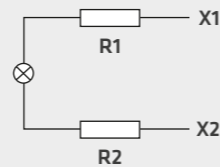



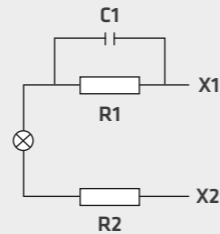





CAPACITY RESISTANCE

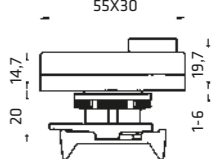



AC 220 ... 380V

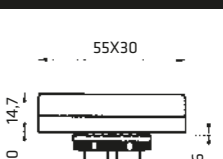



MULTIFUNCTION PUSH BUTTONS Ø22 | NOT LIGHT

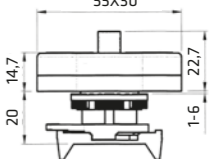

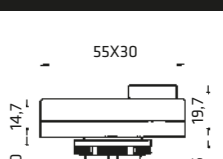

TYPE	COLOUR INDEX	CODE	WEIGHT grams	MIN. PACK QUANTITY	SIZES
		PPDN	38	10	
					

TYPE	COLOUR INDEX	CODE	WEIGHT grams	MIN. PACK QUANTITY	SIZES
		PPDNR	38	10	
		PPDNR.3	38	10	

TYPE	COLOUR INDEX	CODE	WEIGHT grams	MIN. PACK QUANTITY	SIZES
		PPMN	40	10	

MULTIFUNCTION PUSH BUTTONS Ø22 | LIGHT

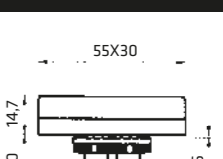
TYPE	COLOUR INDEX	CODE	WEIGHT grams	MIN. PACK QUANTITY	SIZES
		PPDL	30	10	
		PPDL.1	30	10	

TYPE	COLOUR INDEX	CODE	WEIGHT grams	MIN. PACK QUANTITY	SIZES
		PPDLR	30	10	
		PPDLR.3	30	10	

ROTARY SWITCHES Ø22

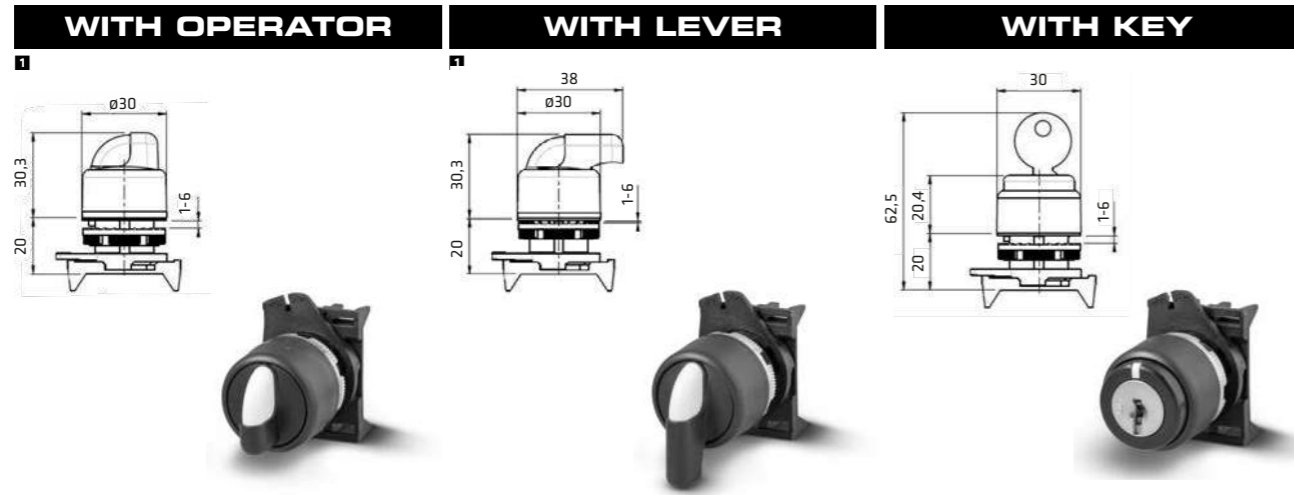

JOYSTICK OPERATORS Ø22 | IP65

2 POSITIONS

Horizontal Vertical

CONTACT BLOCKS	Horizontal			Vertical		
	1	0	2	1	0	2
Left-hand side contact block	NO	X	0	0	0	X
Right-hand side contact block	NO	0	0	X	0	0
	NC	0	0	0	X	0
	NC	X	0	0	0	X

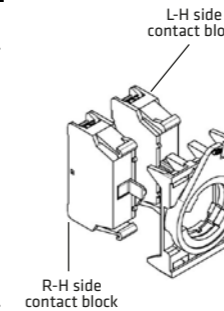

4 POSITIONS

	3	1	0	2	4
Left-hand side contact block	X	0	0	0	0
Right-hand side contact block	0	0	0	0	X
	0	X	0	0	0
	0	0	0	X	0

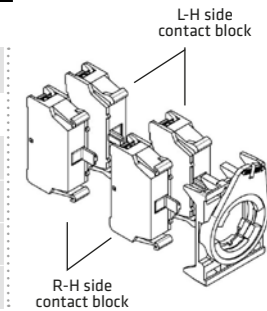

X Contact close
0 Contact open

POSITION	COLOUR INDEX	CODE	COLOUR INDEX	CODE	KEY REMOVAL			CODE
					L	O	R	
90°	■	PSMB1D0	■	PSLB1D0		*		PSCR8D0C
	■	PSMB2D0	■	PSLB2D0			*	PSCR8D0E
	■	PSMB3D0	■	PSLB3D0			*	PSCR8D0N
	■	PSMB4D0	■	PSLB4D0			*	
	■	PSMB5D0	■	PSLB5D0			*	
45°	■	PSMB8D0	■	PSLB8D0			*	
	■	PSMB1D2	■	PSLB1D2		*		PSCR8D2C
	■	PSMB2D2	■	PSLB2D2			*	
	■	PSMB3D2	■	PSLB3D2			*	
	■	PSMB4D2	■	PSLB4D2			*	
45°	■	PSMB5D2	■	PSLB5D2			*	
	■	PSMB8D2	■	PSLB8D2			*	
	■	PSMB1T0	■	PSLB1T0	*	*	*	PSCR8T0C
	■	PSMB2T0	■	PSLB2T0	*	*	*	PSCR8T0A
	■	PSMB3T0	■	PSLB3T0	*	*	*	PSCR8T0E
45°	■	PSMB4T0	■	PSLB4T0	*	*	*	PSCR8T0G
	■	PSMB5T0	■	PSLB5T0	*	*	*	PSCR8T0H
	■	PSMB8T0	■	PSLB8T0	*	*	*	PSCR8T0K
	■	PSMB1T3	■	PSLB1T3			*	PSCR8T3C
	■	PSMB2T3	■	PSLB2T3			*	
45°	■	PSMB3T3	■	PSLB3T3			*	
	■	PSMB4T3	■	PSLB4T3			*	
	■	PSMB5T3	■	PSLB5T3			*	
	■	PSMB8T3	■	PSLB8T3			*	
	45°	■	PSMB1T2	■	PSLB1T2		*	
■		PSMB2T2	■	PSLB2T2			*	PSCR8T2A
■		PSMB3T2	■	PSLB3T2			*	
■		PSMB4T2	■	PSLB4T2			*	
■		PSMB5T2	■	PSLB5T2			*	PSCR8T2H
45°	■	PSMB8T2	■	PSLB8T2		*	*	
	■	PSMB1T1	■	PSLB1T1		*		PSCR8T1C
	■	PSMB2T1	■	PSLB2T1			*	PSCR8T1E
	■	PSMB3T1	■	PSLB3T1			*	
	■	PSMB4T1	■	PSLB4T1			*	
45°	■	PSMB5T1	■	PSLB5T1		*	*	PSCR8T1N
	■	PSMB8T1	■	PSLB8T1		*	*	



POSITION	CODE	WEIGHT	MIN. PACK	SIZES
1 0 2	PMJN8T0	58 grams	5	
1 0 2	PMJN8T3			
1 3 0 4 2	PMJN8Q0			
1 3 0 4 2	PMJN8Q4			
1 0 2	PMJN805			
1-0-2	PMJN80R			

POSITION	CODE	WEIGHT	MIN. PACK	SIZES
1 0 2	PMJN8T01	51 grams	5	
1 0 2	PMJN8T31			
1 3 0 4 2	PMJN8Q01			
1 3 0 4 2	PMJN8Q41			
1 0 2	PMJN80S1			
1-0-2	PMJN80R1			

1 For standard rotary switches suitable to operate a central contact, replace the letter "B" with the letter "C": PSMC
2 For rotary switches with Left - Right operating angles replace the letters "DO" with "SD": PSMB1DO or PSCR8SDE

* Key removable position

AUXILIARY CONTROLS | PEGASUS SERIES
AUXILIARY CONTROLS | PEGASUS SERIES
EMERGENCY PUSH BUTTONS Ø22 | EN ISO 13850

	TYPE	COLOUR INDEX	CODE	WEIGHT grams	MIN. PACK QUANTITY	SIZES
	MUSHROOM OPERATOR Ø30 TWIST TO RELEASE	■	PPFN1R3N	42	10	

	TYPE	COLOUR INDEX	CODE	WEIGHT grams	MIN. PACK QUANTITY	SIZES
	MUSHROOM OPERATOR WITH VISION Ø30 TWIST TO RELEASE	■	PPFN1R3S	44	10	

	TYPE	COLOUR INDEX	CODE	WEIGHT grams	MIN. PACK QUANTITY	SIZES
	MUSHROOM OPERATOR Ø40 TWIST TO RELEASE	■	PPFN1R4N	44	10	

	TYPE	COLOUR INDEX	CODE	WEIGHT grams	MIN. PACK QUANTITY	SIZES
	MUSHROOM OPERATOR WITH VISION Ø40 TWIST TO RELEASE	■	PPFN1R4S	46	10	

	TYPE	COLOUR INDEX	CODE	WEIGHT grams	MIN. PACK QUANTITY	SIZES
	MUSHROOM OPERATOR Ø60 TWIST TO RELEASE	■	PPFN1R6N	50	10	

	TYPE	COLOUR INDEX	CODE	WEIGHT grams	MIN. PACK QUANTITY	SIZES
	MUSHROOM OPERATOR WITH VISION Ø60 TWIST TO RELEASE	■	PPFN1R6S	52	10	

EMERGENCY PUSH BUTTONS Ø40 | EN ISO 13850

	TYPE	COLOUR INDEX	CODE	WEIGHT grams	MIN. PACK QUANTITY	SIZES
	MUSHROOM OPERATOR Ø40 WITH KEY RELEASE	■	PPFN1C4NX (not EN ISO 13850)	76	10	

	TYPE	COLOUR INDEX	CODE	WEIGHT grams	MIN. PACK QUANTITY	SIZES
	MUSHROOM OPERATOR Ø40 PUSH-PULL	■	PPFN1P4N	44	10	

	TYPE	COLOUR INDEX	CODE	WEIGHT grams	MIN. PACK QUANTITY	SIZES
	MUSHROOM OPERATOR Ø40 PUSH-PULL WITH VISION	■	PPFN1P4S	46	10	

	TYPE	COLOUR INDEX	CODE	WEIGHT grams	MIN. PACK QUANTITY	SIZES
	MUSHROOM OPERATOR Ø40 PUSH-PULL WITH COLOUR CAP	■	PPFN1P4C	45	10	

	TYPE	COLOUR INDEX	CODE	WEIGHT grams	MIN. PACK QUANTITY	SIZES
	MUSHROOM OPERATOR Ø40 PUSH-PULL WITH LENS CAP	■	PPFL1P4N	45	10	

TECHNICAL NOTES



- ⚡ All operators comply with the relevant European standard.
- ⚡ EN ISO 13850: Machine safety - Emergency stop operators, functional characteristics - Design guidelines.
- ⚡ IEC/EN6097-5-1.
- ⚡ Comply with the standard IEC/EN60204-1: Machine safety - Machine electrical circuits - General guidelines.
- ⚡ The push buttons are designed with a load charge mechanism to ensure a reliable operation and stoppage, or blockage, in the activate position. The combination with positive switching NC contacts and the presence of the "status" indicator on some models, guarantee a high degree of reliability and effectiveness.

AUXILIARY CONTROLS | PEGASUS SERIES

AUXILIARY CONTROLS | PEGASUS SERIES

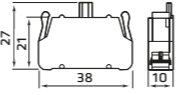

CONTACT BLOCKS | SPRING LOADED TERMINALS



DESIGNATION	FUNCTION	CODE	SIZES
1 — NC — 2	 0 1,5 6 mm	PCW01	
3 — NO — 4	 0 3,5 6 mm	PCW10	

CONTACT BLOCKS | WELDING TERMINALS

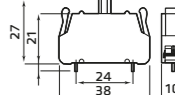

DESIGNATION	FUNCTION	CODE	SIZES
1 — NC — 2	 0 1,5 6 mm	PSC01	
3 — NO — 4	 0 3,5 6 mm	PSC10	

LAMPHOLDER BA9s

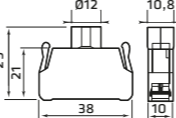

DESIGNATION	POWER SUPPLY	CODE	SIZES
X1 — ⊗ — X2	BA9s Lamp socket 250V 2,4 W max Bulb not included	PCWAD	

LAMPHOLDER BA9s

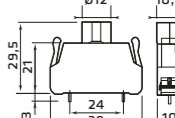

DESIGNATION	POWER SUPPLY	CODE	SIZES
X1 — ⊗ — X2	BA9s Lamp socket 250V 2,4 W max Bulb not included	PSCAD	

LAMPHOLDER WITH BUILT-IN LED

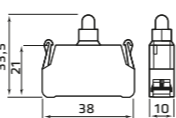

DESIGNATION	POWER SUPPLY	CODE	SIZES
X1 — ⊗ — X2	AC/DC 12V	PCW5L12	
	AC/DC 24V	PCW5L24	
	AC/DC 48V	PCW5L48	
	AC/DC 110V	PCW5L110	
	AC 220V	PCW5L220	

LAMPHOLDER WITH BUILT-IN LED



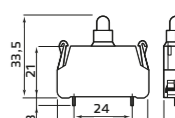

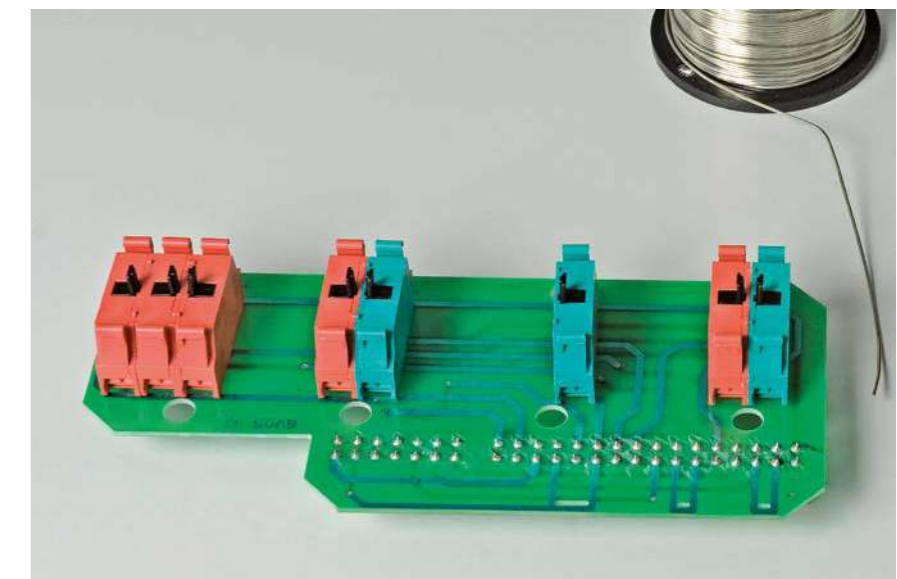
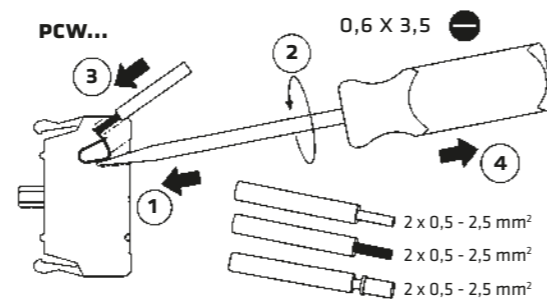
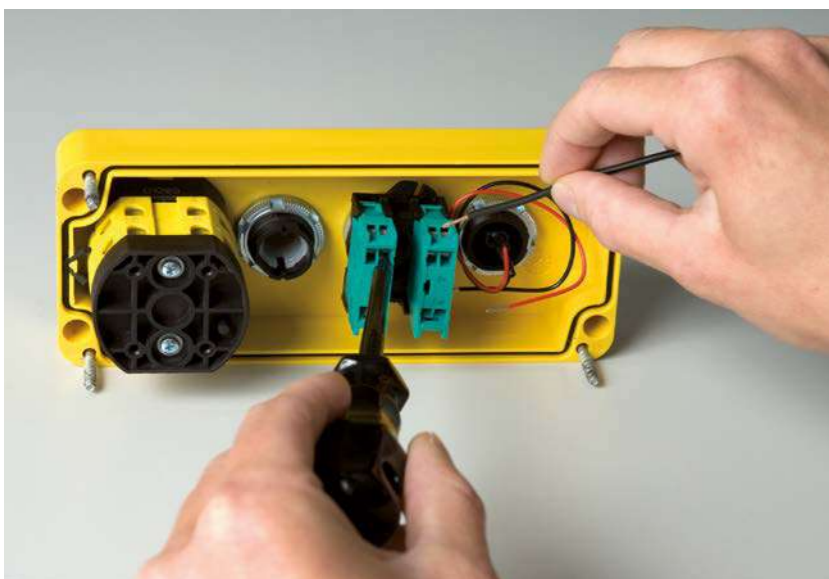

DESIGNATION	POWER SUPPLY	CODE	SIZES
X1 — ⊗ — X2	AC/DC 12V	PSC5L12	
	AC/DC 24V	PSC5L24	
	AC/DC 48V	PSC5L48	
	AC/DC 110V	PSC5L110	
	AC 220V	PSC5L220	



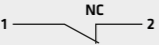

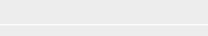
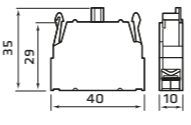
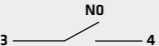
CONTACT BLOCKS | SCREW TERMINALS

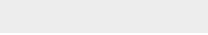

DESIGNATION	FUNCTION	CODE	SIZES
 1 — NC — 2	  	PL004001	
 3 — NO — 4	  	PL004002	

LAMPHOLDER BA9s

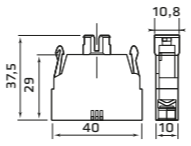

DESIGNATION	POWER SUPPLY	CODE	SIZES
X1 —  — X2	BA9s Lamp socket 250V 2,4 W max Bulb not included	PL004007	



LAMPHOLDER WITH BUILT-IN LED

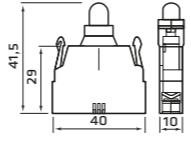

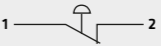

DESIGNATION	POWER SUPPLY	CODE	SIZES
X1 —  — X2	AC/DC 12V	PL0045L12	
	AC/DC 24V	PL0045L24	
	AC/DC 48V	PL0045L48	
	AC/DC 110V	PL0045L110	
	AC 220V	PL0045L220	

CONTROL STATION WITH MUSHROOM Ø90 | IP66

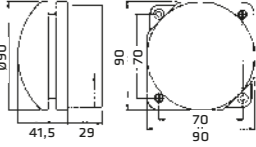



TYPE	COLOUR INDEX	DESIGNATION	CODE	SIZES
MUSHROOM HEAD MOMENTARY		 1 — 2 	PG1M9W01	

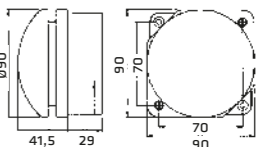

TYPE	COLOUR INDEX	DESIGNATION	CODE	SIZES
MUSHROOM HEAD MOMENTARY		 3 — 4	PG8M9W10	

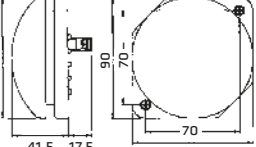

TYPE	COLOUR INDEX	DESIGNATION	CODE	SIZES
MUSHROOM HEAD MOMENTARY FLUSH MOUNTING		 1 — 2 	PR1M9W01	



ELECTRICAL CHARACTERISTICS

- ⊕ Protection EN60529 IP66.
- ⊕ Double insulated.
- ⊕ Number contact capacity: max 3 contact blocks.
- ⊕ Cable entry with 3 holes Pg 13,5/M20.
- ⊕ Ambient temperature:
 - operating: -25 +70°C
 - storage: -30 +70°C
- ⊕ Climate protection: IEC 68 2-3, 2-30.
- ⊕ Terminals referencing: EN50013.
- ⊕ Colors:
 - Red mushroom;
 - Yellow cover;
 - Black box.

 - Black mushroom;
 - Grey cover;
 - Black box.

AUXILIARY CONTROLS | PEGASUS SERIES
AUXILIARY CONTROLS | PEGASUS SERIES
PUSH BUTTON STATIONS | IP65

	TYPE	COLOUR	DESIGNATION	CODE	WEIGHT grams	MIN. PACK	SIZES
	FLUSH PUSH BUTTON NOT LATCHING	■		PQ01RN1	176	1	
		■		PQ01RN2			

	TYPE	COLOUR	DESIGNATION	CODE	WEIGHT grams	MIN. PACK	SIZES
	EMERGENCY STOP Ø40 NOT LATCHING	■		PQ01M4N	192	1	

	TYPE	COLOUR	DESIGNATION	CODE	WEIGHT grams	MIN. PACK	SIZES
	EMERGENCY STOP Ø60 NOT LATCHING	■		PQ01M6N	198	1	

	TYPE	COLOUR	DESIGNATION	CODE	WEIGHT grams	MIN. PACK	SIZES
	WITH NR. 2 PUSH BUTTONS	 	 	PQ02B	264	1	

	TYPE	COLOUR	DESIGNATION	CODE	WEIGHT grams	MIN. PACK	SIZES
	WITH NR. 1 PUSH BUTTONS AND NR. 1 EMERGENCY EN ISO 13850	 	 	PQ02A	264	1	

	TYPE	COLOUR	DESIGNATION	CODE	WEIGHT grams	MIN. PACK	SIZES
	WITH NR. 2 PUSH BUTTONS AND NR. 1 EMERGENCY EN ISO 13850	 	 	PQ03B	362	1	

PUSH BUTTON STATIONS | EN ISO 13850 IP65

	TYPE	COLOUR	DESIGNATION	CODE	WEIGHT grams	MIN. PACK	SIZES
	EMERGENCY STOP Ø40 TWIST TO RELEASE	■		PQ01R4N	190	1	

	TYPE	COLOUR	DESIGNATION	CODE	WEIGHT grams	MIN. PACK	SIZES
	EMERGENCY STOP Ø40 PUSH-PULL	■		PQ01P4N	192	1	

	TYPE	COLOUR	DESIGNATION	CODE	WEIGHT grams	MIN. PACK	SIZES
	EMERGENCY STOP PUSH BUTTON Ø40 PUSH-PULL WITH VISION	■		PQ01P4L 1	190	1	

	TYPE	COLOUR	DESIGNATION	CODE	WEIGHT grams	MIN. PACK	SIZES
	EMERGENCY STOP Ø60 PUSH-PULL	■		PQ01P6N	198	1	

TECHNICAL NOTES

- All operators comply with the relevant European standard.
- EN ISO 13850: Machine safety - Emergency stop operators, functional characteristics - Design guidelines.
- IEC/EN6097-5-1.
- Comply with the standard IEC/EN60204-1: Machine safety - Machine electrical circuits - General guidelines.
- The push buttons are designed with a load charge mechanism to ensure a reliable operation and stoppage, or blockage, in the activate position. The combination with positive switching NC contacts and the presence of the "status" indicator on some models, guarantee a high degree of reliability and effectiveness.

PUSH BUTTON STATION ENCLOSURES | IP65



TYPE	COVER COLOUR	CODE	WEIGHT grams	MIN. PACK QUANTITY	SIZES
1 HOLES ENCLOSURE	■	PQ01K	134	1	
	■	PQ01KGN			



TYPE	COVER COLOUR	CODE	WEIGHT grams	MIN. PACK QUANTITY	SIZES
2 HOLES ENCLOSURE	■	PQ02K	174	1	
	■	PQ02KGN			



TYPE	COVER COLOUR	CODE	WEIGHT grams	MIN. PACK QUANTITY	SIZES
3 HOLES ENCLOSURE	■	PQ03K	214	1	
	■	PQ03KGN			



TYPE	COVER COLOUR	CODE	WEIGHT grams	MIN. PACK QUANTITY	SIZES
4 HOLES ENCLOSURE	■	PQ04K	256	1	
	■	PQ04KGN			

PUSH BUTTON STATION ENCLOSURES | IP65



TYPE	COVER COLOUR	CODE	WEIGHT grams	MIN. PACK QUANTITY	SIZES
5 HOLES ENCLOSURE	■	PQ05K	296	1	
	■	PQ05KGN			



TYPE	COVER COLOUR	CODE	WEIGHT grams	MIN. PACK QUANTITY	SIZES
3 HOLES ENCLOSURE	■	PQ06K	386	1	
	■	PQ06KGN			

CHARACTERISTICS

- ABS self-extinguishing material.
- Self-extinguishing class V0 UL94.
- EN60529 IP65 protection grade.
- Double insulation
- Colors: Black box; Yellow cover; Grey cover.
- Threaded cable entry with membrane conduit knock:
 - 1 hole box nr. 1 M16 + 1 M20 gland, from 2 to 5 holes nr. 2 M20 glands;
 - 6 holes nr. 1 M20 + 1 M25 glands

ASSEMBLING

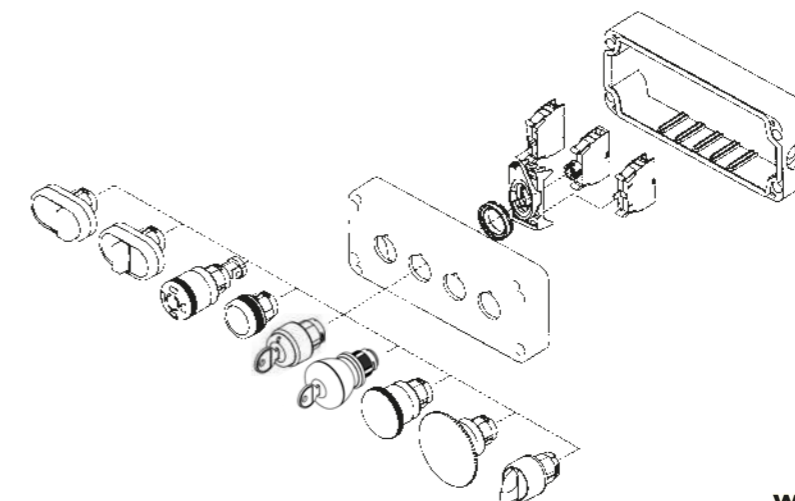

ACCESSORIES

DIN RAIL MOUNTING ADAPTOR



DESCRIPTION	CODE
DIN EN50022 RAIL MOUNTING FOR 46 MM STANDARDISED GREY ENCLOSURES	11708351

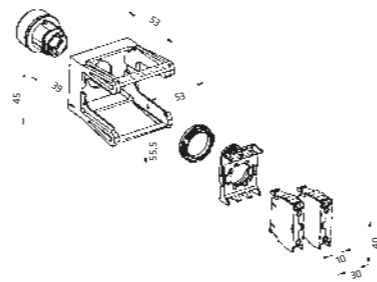

PROTECTION CAPS

FOR FLUSH BUTTON

DESCRIPTION	CODE
PEGASUS	PCR



FOR MULTIFUNCTIONAL SERIES

PEGASUS	CODE
PPDN-PPDL	PCD
PPMN	PCM
PPDNR-PPDLR	PCN



FOR EXTENDED PUSH BUTTON

DESCRIPTION	CODE
PEGASUS	PCS



CENTRAL CONTACT OPERATION



DESCRIPTION	CODE
FOR PUSH BUTTONS STABLE-UNSTABLE	PAC

KEY FIXING BULB EXTRACTOR



CODE
PCF

STOPPER CLOSING HOLES Ø22,5



CODE
PTRN8

CONTACTS SUPPORT



DESCRIPTION	CODE	DESCRIPTION	CODE
TO CONTACT ELEMENTS PL, PCW, PSC	PPELN8	TO FIVE CONTACT ELEMENTS PL, PCW, PSC	PPELN8-5

FASTON CONNECTORS AND FOR PCB



DESCRIPTION	CODE	DESCRIPTION	CODE
FASTON 6,3x0,8	11708341	PCB	11708235

TO SCREW CONTACTS PL

OPERATOR CAPS Ø22

MOMENTARY AND LATCHED, FLUSH PUSH BUTTONS



SYMBOL	COLOUR	CODE
	■	PPRN2/I
	■	PPRN1/O
	■	PPRN2/II
	■	PPRN2/START
	■	PPRN1/STOP

SYMBOL	COLOUR	CODE
	■	PPRN2/ON
	■	PPRN1/OFF
	■	PPRN5/F
	■	PPRN8/F

Available others symbols on request, also in different languages and colours.

EMERGENCY STOP RING

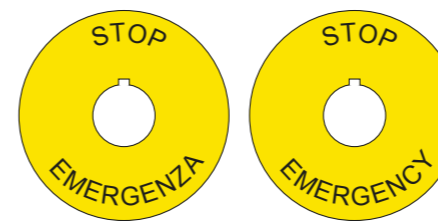

DESCRIPTION	TEXT	CODE
Ø60 Made of Aluminium Yellow background Black letters. Weight 3,5 gr. Min. packing q.ty 10 pcs.	(BLANK)	PTE
	STOP - EMERGENZA	PTE/I
	EMERGENCY - STOP	PTE/A
	NOT - AUS	PTE/D

Available others texts on request, also in different languages.

LEGEND PLATE



CODE
PPTN8

LABEL



TEXT	CODE
(BLANK)	PTA00
MARCIA	PTA01
ARRESTO	PTA02
I O II	PTA03
O I	PTA04
CHIUDE	PTA05
APRE	PTA06
EMERGENZA	PTA07
MANUALE	PTA08
AUTOMATICO	PTA09
AVANTI	PTA10
INDIETRO	PTA11
EIN	PTA12
AUS	PTA13
STOP	PTA14
START	PTA15
RESET	PTA16
I → 0 ← II	PTA17
AUT 0 MAN	PTA18
INS - DISINS	PTA26
HAND OFF AUTO	PTA27
FORW OFF REV	PTA28
ON OFF	PTA29

TECHNICAL DATA | ELECTRICAL CHARACTERISTICS
CONTACT BLOCKS

EC/EN 60947-5-1 CHARACTERISTICS		P0004001-P0004002		PCW01-PCW10 / PSC01-PSC10	
Rated insulation voltage Ui	V	690*		690*	
Rated impulse withstand voltage Uimp	kV	4*		4*	
Operating frequency	Hz	50/60*		50/60*	
Rated thermal current Ith	A	16*		16*	
Rated thermal current in enclosed Ithe	A	10*		10*	

RATED OPERATING CURRENT Ie:		P0004001-P0004002		PCW01-PCW10 / PSC01-PSC10													
AC15: Alternate current	V	24	60	110	230	400	440	500	690	24	60	110	240	400	440	500	690
	A	16*	12	8	6	4,5	3,5	1*	1	16*	12	5	5*	4	4	4*	2*
DC13: Direct current	V	24	48	60	110	220	24	48	60	110	250						
	A	2*	1,2	0,85	0,4	0,25*	2	2*	1*	0,4	0,4*						
Conditional short circuit withstand current	A	1000*		1000*													
Fuse rating gG	500V	10A*		10A*													
Contact insulation resistance	mΩ	<25		<25													
Switching mechanism		Slow break double gap contacts		Slow break double gap contacts													
Contact duty		☉ NC contact with positive opening		☉ NC contact with positive opening													
Minimum tripping force		4N		4N													
Electrical life AC15	mil. cycles	1A/1,5 - 2A/0,5 - 3A/0,25		1A/1,5 - 2A/0,5 - 3A/0,25													

UL 508 CHARACTERISTICS		P0004001-P0004002		PCW01-PCW10 / PSC01-PSC10	
General Use		10A-600V ac - 2,5A-125V dc		10A-600V ac - 2,5A-125V dc	
Heavy Duty (HD) category		A600-Q600		A600-Q600	

LAMP HOLDER

EC/EN 60947-5-1 CHARACTERISTICS		BA9s		BUILT-IN LED	
		DIRECT P0004007 PCWAD-PSCAD		LED P0004.L. PCW.L.-PSC.L.	
Rated insulation voltage Ui	V	690*		400	
Rated operating voltage Ue	V	400* 300 1		AC/DC 12-24	
	V	-		AC/DC 48	
	V	-		AC/DC 110	
	V	-		AC 220	
Max rated power	W	2,4* 2,5 1		-	
Power supply		AC/DC		-	
Lamp fixing system		BA9s		-	

TECHNICAL DATA | ELECTRICAL CHARACTERISTICS

STANDARD CONFORMITY		UL - IMG - CCC - EAC - R.I.N.A	
Approvals		IEC/EN60947-5-1, UL508	
Protection class	EN 60529	IP65: Buttons and switches, joysticks, single-lamp IP66/IP67/IP69K: Mushroom emergency EN ISO 13850 IP40: Multi-function push buttons IP66: Buttons with protection caps Type 1 IP65: Control stations, enclosures IP66: Mushroom, Push button Ø90 IP20: Contacts PCW, PL. IP00: PSC.	
	Conforms to UL50 EN 60529		
Material Group	EN60947-1	II	
Pollution Grade	EN60947-1	3	
Flammability	UL94	VO: live parts	
Ambient Temperature	°C	Operating: -25 +70 Storage: -30 +70	
Climate Protection	IEC68 part 2-3 IEC68 part 2-30	Hot damp Unsettled Hot damp	
Terminals referecing		EN50013	
Terminals:			
Terminal block caliber		A2	
Terminal screw		M3,5	
Tightening torque		1,2 Nm - EN60947-1 - 12 lb.in. UL508	
Capacity:			
Solid and flexible conductors	n° 1 min/max mm² n° 2 min/max mm² AWG	1/2,5 screw terminals, 0,5-2,5 spring loaded terminals 1/2,5 screw terminals, 0,5-2,5 spring loaded terminals 20-12 screw terminals, 20-12 spring loaded terminals	
Mechanical life:			
Mushroom operators and standard		3	
Push buttons with colour cap	mil./operations		
Standard push buttons with lens cap		1	
Latched push buttons with colour cap		1	
Standard rotary switches		1	
Rotary switches with lens, latched push button with lens cap, joystick		0,5	
Emergency stop push buttons with release		0,3	



GIOVENZANA
INTERNATIONAL B.V.



GIOVENZANA
INTERNATIONAL B.V.



AUXILIARY CONTROLS
ORION SERIES

AUXILIARY CONTROLS | ORION SERIES | BLACK LINE

AUXILIARY CONTROLS | ORION SERIES | BLACK LINE

PUSH BUTTONS Ø22 | WITH COLOUR CAP | IP65

MOMENTARY

TYPE	COLOUR INDEX	CODE	WEIGHT grams	MIN. PACK QUANTITY	SIZES
FLUSH PUSH BUTTON	■	PPRN1BL	30	10	
	■	PPRN2BL	30	10	
	■	PPRN3BL	30	10	
	■	PPRN4BL	30	10	
	■	PPRN5BL	30	10	
	■	PPRN8BL	30	10	

TYPE	COLOUR INDEX	CODE	WEIGHT grams	MIN. PACK QUANTITY	SIZES
EXTENDED PUSH BUTTON	■	PPSN1BL	31	10	
	■	PPSN2BL	31	10	
	■	PPSN3BL	31	10	
	■	PPSN4BL	31	10	
	■	PPSN5BL	31	10	
	■	PPSN8BL	31	10	

TYPE	COLOUR INDEX	CODE	WEIGHT grams	MIN. PACK QUANTITY	SIZES
MUSHROOM Ø40	■	PPFN1M4NBL	45	10	
	■	PPFN2M4NBL	45	10	
	■	PPFN3M4NBL	45	10	

PUSH BUTTONS Ø22 | WITH LENS CAP | IP65

MOMENTARY

TYPE	COLOUR INDEX	CODE	WEIGHT grams	MIN. PACK QUANTITY	SIZES
FLUSH PUSH BUTTON	■	PPRL1BL	30	10	
	■	PPRL2BL	30	10	
	■	PPRL3BL	30	10	
	■	PPRL4BL	30	10	
	■	PPRL5BL	30	10	

TYPE	COLOUR INDEX	CODE	WEIGHT grams	MIN. PACK QUANTITY	SIZES
EXTENDED PUSH BUTTON	■	PPSL1BL	31	10	
	■	PPSL2BL	31	10	
	■	PPSL3BL	31	10	
	■	PPSL4BL	31	10	
	■	PPSL5BL	31	10	

TYPE	COLOUR INDEX	CODE	WEIGHT grams	MIN. PACK QUANTITY	SIZES
MUSHROOM OPERATOR Ø40	■	PPFL1M4NBL	43	10	

IND. LIGHT

TYPE	COLOUR INDEX	CODE	WEIGHT grams	MIN. PACK QUANTITY	SIZES
FLAT CAP	■	PLSL1NL	30	10	
	■	PLSL2NL	30	10	
	■	PLSL3NL	30	10	
	■	PLSL4NL	30	10	
	■	PLSL5NL	30	10	

MULTIFUNCTION PUSH BUTTONS Ø22 | NOT LIGHT | IP65

TYPE	COLOUR INDEX	CODE	WEIGHT grams	MIN. PACK QUANTITY	SIZES
DUAL PUSH BUTTON	■	PPDNBL	38	10	

TYPE	COLOUR INDEX	CODE	WEIGHT grams	MIN. PACK QUANTITY	SIZES
EXTENDED DUAL PUSH BUTTON	■	PPDNSBL	38	10	

TYPE	COLOUR INDEX	CODE	WEIGHT grams	MIN. PACK QUANTITY	SIZES
MULTIFUNCTION PUSH BUTTON	■	PPMNSBL	40	10	

MULTIFUNCTION PUSH BUTTONS Ø22 | LIGHT | IP65

TYPE	COLOUR INDEX	CODE	WEIGHT grams	MIN. PACK QUANTITY	SIZES
DUAL PUSH BUTTON	■	PPDLBL	38	10	
	■	PPDLBL.1	38	10	

TYPE	COLOUR INDEX	CODE	WEIGHT grams	MIN. PACK QUANTITY	SIZES
EXTENDED DUAL PUSH BUTTON	■	PPDLSBL	38	10	

ROTARY SWITCHES Ø22 | IP65

WITH OPERATOR

WITH LIGHT OPERATOR

WITH KEY



POSITION	COLOUR INDEX	CODE	COLOUR INDEX	CODE	KEY REMOVAL			CODE
					L	O	R	
90°	■	PSMB1D0BL	■	PSML1D0BL		*		PSCR8D0CBL
	■	PSMB2D0BL	■	PSML2D0BL			*	PSCR8D0EBL
	■	PSMB3D0BL	■	PSML3D0BL			*	PSCR8D0NBL
	■	PSMB4D0BL	■	PSML4D0BL				
	■	PSMB5D0BL	■	PSML5D0BL				
	■	PSMB8D0BL	■	PSML8D0BL				
45°	■	PSMB1D1BL	■	PSML1D1BL		*		PSCR8D1CBL
	■	PSMB2D1BL	■	PSML2D1BL			*	PSCR8D1EBL
	■	PSMB3D1BL	■	PSML3D1BL			*	PSCR8D1NBL
	■	PSMB4D1BL	■	PSML4D1BL				
	■	PSMB5D1BL	■	PSML5D1BL				
	■	PSMB8D1BL	■	PSML8D1BL				
45°	■	PSMB1D2BL	■	PSML1D2BL			*	PSCR8D2CBL
	■	PSMB2D2BL	■	PSML2D2BL				
	■	PSMB3D2BL	■	PSML3D2BL				
	■	PSMB4D2BL	■	PSML4D2BL				
	■	PSMB5D2BL	■	PSML5D2BL				
	■	PSMB8D2BL	■	PSML8D2BL				
45°	■	PSMB1T0BL	■	PSML1T0BL	*	*		PSCR8T0CBL
	■	PSMB2T0BL	■	PSML2T0BL	*	*	*	PSCR8T0ABL
	■	PSMB3T0BL	■	PSML3T0BL	*	*	*	PSCR8T0EBL
	■	PSMB4T0BL	■	PSML4T0BL	*	*	*	PSCR8T0GBL
	■	PSMB5T0BL	■	PSML5T0BL	*	*	*	PSCR8T0HBL
	■	PSMB8T0BL	■	PSML8T0BL	*	*	*	PSCR8T0KBL
45°	■	PSMB1T3BL	■	PSML1T3BL			*	PSCR8T3CBL
	■	PSMB2T3BL	■	PSML2T3BL				
	■	PSMB3T3BL	■	PSML3T3BL				
	■	PSMB4T3BL	■	PSML4T3BL				
	■	PSMB5T3BL	■	PSML5T3BL				
	■	PSMB8T3BL	■	PSML8T3BL				
45°	■	PSMB1T2BL	■	PSML1T2BL		*		PSCR8T2CBL
	■	PSMB2T2BL	■	PSML2T2BL			*	PSCR8T2ABL
	■	PSMB3T2BL	■	PSML3T2BL			*	PSCR8T2HBL
	■	PSMB4T2BL	■	PSML4T2BL				
	■	PSMB5T2BL	■	PSML5T2BL				
	■	PSMB8T2BL	■	PSML8T2BL				
45°	■	PSMB1T1BL	■	PSML1T1BL		*		PSCR8T1CBL
	■	PSMB2T1BL	■	PSML2T1BL			*	PSCR8T1EBL
	■	PSMB3T1BL	■	PSML3T1BL			*	PSCR8T1NBL
	■	PSMB4T1BL	■	PSML4T1BL				
	■	PSMB5T1BL	■	PSML5T1BL				
	■	PSMB8T1BL	■	PSML8T1BL				

OPERATOR CAPS Ø22 | IP65

MOMENTARY FLUSH PUSH BUTTONS



SYMBOL	COLOUR	CODE	SYMBOL	COLOUR	CODE
	■	PPRN2BL/I		■	PPRN2BL/ON
	■	PPRN1BL/O		■	PPRN1BL/OFF
	■	PPRN2BL/II		■	PPRN5BL/F
	■	PPRN2BL/START		■	PPRN8BL/F
	■	PPRN1BL/STOP			

Available others symbols on request, also in different languages and colours.

1 For standard rotary switches suitable to operate a central contact, replace the letter "B" with the letter "C": PSMB1C0BL or PSML1C0BL
2 For rotary switches with Left - Right operating angles replace the letters "DO" with "SD": PSMB1SD0BL or PSCR8SD0BL

* Key removable position

AUXILIARY CONTROLS | ORION SERIES | GREY LINE

AUXILIARY CONTROLS | ORION SERIES | GREY LINE

PUSH BUTTONS Ø22 | WITH COLOUR CAP | IP67-IP69K

MOMENTARY

TYPE	COLOUR INDEX	CODE	WEIGHT grams	MIN. PACK QUANTITY	SIZES
FLUSH PUSH BUTTON	■	PPRN1GL	30	10	
	■	PPRN2GL	30	10	
	■	PPRN3GL	30	10	
	■	PPRN4GL	30	10	
	■	PPRN5GL	30	10	
	■	PPRN8GL	30	10	

TYPE	COLOUR INDEX	CODE	WEIGHT grams	MIN. PACK QUANTITY	SIZES
EXTENDED PUSH BUTTON	■	PPSN1GL	31	10	
	■	PPSN2GL	31	10	
	■	PPSN3GL	31	10	
	■	PPSN4GL	31	10	
	■	PPSN5GL	31	10	
	■	PPSN8GL	31	10	

TYPE	COLOUR INDEX	CODE	WEIGHT grams	MIN. PACK QUANTITY	SIZES
MUSHROOM Ø40	■	PPFN1M4NGL	45	10	
	■	PPFN2M4NGL	45	10	
	■	PPFN3M4NGL	45	10	

PUSH BUTTONS Ø22 | WITH LENS CAP | IP67-IP69K

MOMENTARY

TYPE	COLOUR INDEX	CODE	WEIGHT grams	MIN. PACK QUANTITY	SIZES
FLUSH PUSH BUTTON	■	PPRL1GL	30	10	
	■	PPRL2GL	30	10	
	■	PPRL3GL	30	10	
	■	PPRL4GL	30	10	
	■	PPRL5GL	30	10	

TYPE	COLOUR INDEX	CODE	WEIGHT grams	MIN. PACK QUANTITY	SIZES
EXTENDED PUSH BUTTON	■	PPSL1GL	31	10	
	■	PPSL2GL	31	10	
	■	PPSL3GL	31	10	
	■	PPSL4GL	31	10	
	■	PPSL5GL	31	10	

TYPE	COLOUR INDEX	CODE	WEIGHT grams	MIN. PACK QUANTITY	SIZES
MUSHROOM OPERATOR Ø40	■	PPFL1M4NGL	43	10	

IND. LIGHT

TYPE	COLOUR INDEX	CODE	WEIGHT grams	MIN. PACK QUANTITY	SIZES
FLAT CAP	■	PLSL1NL	30	10	
	■	PLSL2NL	30	10	
	■	PLSL3NL	30	10	
	■	PLSL4NL	30	10	
	■	PLSL5NL	30	10	

MULTIFUNCTION PUSH BUTTONS Ø22 | NOT LIGHT | IP67-IP69K

TYPE	COLOUR INDEX	CODE	WEIGHT grams	MIN. PACK QUANTITY	SIZES
DUAL PUSH BUTTON	■	PPDNGL	38	10	

TYPE	COLOUR INDEX	CODE	WEIGHT grams	MIN. PACK QUANTITY	SIZES
EXTENDED DUAL PUSH BUTTON	■	PPDNSGL	38	10	

TYPE	COLOUR INDEX	CODE	WEIGHT grams	MIN. PACK QUANTITY	SIZES
MULTIFUNCTION PUSH BUTTON	■	PPMNSGL	40	10	

MULTIFUNCTION PUSH BUTTONS Ø22 | LIGHT | IP67-IP69K

TYPE	COLOUR INDEX	CODE	WEIGHT grams	MIN. PACK QUANTITY	SIZES
DUAL PUSH BUTTON	■	PPDLGL	38	10	
	■	PPDLGL.1	38	10	

TYPE	COLOUR INDEX	CODE	WEIGHT grams	MIN. PACK QUANTITY	SIZES
EXTENDED DUAL PUSH BUTTON	■	PPDLSGL	38	10	

ROTARY SWITCHES Ø22 | IP67-IP69K

WITH OPERATOR

WITH LIGHT OPERATOR

WITH KEY



POSITION	COLOUR INDEX	CODE	COLOUR INDEX	CODE	KEY REMOVAL			CODE
					L	O	R	
 90°	■	PSMB1D0GL	■	PSML1D0GL		*		PSCR8D0CGL
	■	PSMB2D0GL	■	PSML2D0GL			*	PSCR8D0EGL
	■	PSMB3D0GL	■	PSML3D0GL			*	PSCR8D0NGL
	■	PSMB4D0GL	■	PSML4D0GL			*	
	■	PSMB5D0GL	■	PSML5D0GL			*	
	■	PSMB8D0GL	■	PSML8D0GL			*	
 45°	■	PSMB1D1GL	■	PSML1D1GL		*		PSCR8D1CGL
	■	PSMB2D1GL	■	PSML2D1GL			*	PSCR8D1EGL
	■	PSMB3D1GL	■	PSML3D1GL			*	PSCR8D1NGL
	■	PSMB4D1GL	■	PSML4D1GL			*	
	■	PSMB5D1GL	■	PSML5D1GL			*	
	■	PSMB8D1GL	■	PSML8D1GL			*	
 45°	■	PSMB1D2GL	■	PSML1D2GL			*	PSCR8D2CGL
	■	PSMB2D2GL	■	PSML2D2GL			*	
	■	PSMB3D2GL	■	PSML3D2GL			*	
	■	PSMB4D2GL	■	PSML4D2GL			*	
	■	PSMB5D2GL	■	PSML5D2GL			*	
	■	PSMB8D2GL	■	PSML8D2GL			*	
 45°	■	PSMB1T0GL	■	PSML1T0GL	*	*		PSCR8T0CGL
	■	PSMB2T0GL	■	PSML2T0GL	*	*	*	PSCR8T0AGL
	■	PSMB3T0GL	■	PSML3T0GL	*	*	*	PSCR8T0EGL
	■	PSMB4T0GL	■	PSML4T0GL	*	*	*	PSCR8T0GGL
	■	PSMB5T0GL	■	PSML5T0GL	*	*	*	PSCR8T0HGL
	■	PSMB8T0GL	■	PSML8T0GL	*	*	*	PSCR8T0KGL
 45°	■	PSMB1T3GL	■	PSML1T3GL			*	PSCR8T3CGL
	■	PSMB2T3GL	■	PSML2T3GL			*	
	■	PSMB3T3GL	■	PSML3T3GL			*	
	■	PSMB4T3GL	■	PSML4T3GL			*	
	■	PSMB5T3GL	■	PSML5T3GL			*	
	■	PSMB8T3GL	■	PSML8T3GL			*	
 45°	■	PSMB1T2GL	■	PSML1T2GL		*		PSCR8T2CGL
	■	PSMB2T2GL	■	PSML2T2GL			*	PSCR8T2AGL
	■	PSMB3T2GL	■	PSML3T2GL			*	PSCR8T2HGL
	■	PSMB4T2GL	■	PSML4T2GL			*	
	■	PSMB5T2GL	■	PSML5T2GL			*	
	■	PSMB8T2GL	■	PSML8T2GL			*	
 45°	■	PSMB1T1GL	■	PSML1T1GL		*		PSCR8T1CGL
	■	PSMB2T1GL	■	PSML2T1GL			*	PSCR8T1EGL
	■	PSMB3T1GL	■	PSML3T1GL			*	PSCR8T1NGL
	■	PSMB4T1GL	■	PSML4T1GL			*	
	■	PSMB5T1GL	■	PSML5T1GL			*	
	■	PSMB8T1GL	■	PSML8T1GL			*	

1 For standard rotary switches suitable to operate a central contact, replace the letter "B" with the letter "C": PSMC
2 For rotary switches with Left - Right operating angles replace the letters "DO" with "SD": PSMB1DO or PSCR8SDE

* Key removable position

OPERATOR CAPS Ø22 | IP67-IP69K

MOMENTARY FLUSH PUSH BUTTONS



SYMBOL	COLOUR	CODE	SYMBOL	COLOUR	CODE
	■	PPRN2GL/I		■	PPRN2GL/ON
	■	PPRN1GL/O		■	PPRN1GL/OFF
	■	PPRN2GL/II		■	PPRN5GL/F
	■	PPRN2GL/START		■	PPRN8GL/F
	■	PPRN1GL/STOP			

Available others symbols on request, also in different languages and colours.

ACCESSORIES | ORION SERIES

DIN RAIL MOUNTING ADAPTOR



DESCRIPTION	CODE
DIN EN50022 RAIL MOUNTING FOR 46 MM STANDARDISED GREY ENCLOSURES	11708351

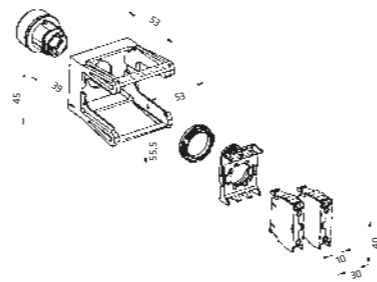

PROTECTION CAPS

FOR FLUSH BUTTON

DESCRIPTION	CODE
ORION	PCRNL



FOR MULTIFUNCTIONAL SERIES

ORION	CODE
PPDNGL-PPDLGL	PCDNL
PPMNGL	PCMNL
PPDNRGL-PPDLRGL	PCNNL



FOR EXTENDED PUSH BUTTON

DESCRIPTION	CODE
ORION	PCSNL



CENTRAL CONTACT OPERATION



DESCRIPTION	CODE
FOR GL, BL, NEMA 4X SERIES	11708555

KEY FIXING BULB EXTRACTOR



CODE
PCF

STOPPER CLOSING HOLES Ø22,5



CODE
PTRN8

CONTACTS SUPPORT



DESCRIPTION	CODE	DESCRIPTION	CODE
TO CONTACT ELEMENTS PL, PCW, PSC	PPELN8	TO FIVE CONTACT ELEMENTS PL, PCW, PSC	PPELN8-5

FASTON CONNECTORS AND FOR PCB



DESCRIPTION	CODE	DESCRIPTION	CODE
FASTON 6,3x0,8	11708341	PCB	11708235

TO SCREW CONTACTS PL

ACCESSORIES | ORION SERIES

EMERGENCY STOP RING

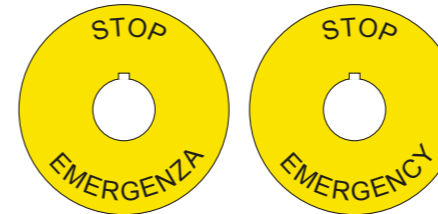

DESCRIPTION	TEXT	CODE
Ø60 Made of Aluminium Yellow background Black letters. Weight 3,5 gr. Min. packing q.ty 10 pcs.	(BLANK)	PTE
	STOP - EMERGENZA	PTE/I
	EMERGENCY - STOP	PTE/A
	NOT - AUS	PTE/D

Available others texts on request, also in different languages.

LEGEND PLATE



CODE
PPTN8

LABEL



TEXT	CODE
(BLANK)	PTA00
MARCIA	PTA01
ARRESTO	PTA02
I O II	PTA03
O I	PTA04
CHIUDE	PTA05
APRE	PTA06
EMERGENZA	PTA07
MANUALE	PTA08
AUTOMATICO	PTA09
AVANTI	PTA10
INDIETRO	PTA11
EIN	PTA12
AUS	PTA13
STOP	PTA14
START	PTA15
RESET	PTA16
I → 0 ← II	PTA17
AUT 0 MAN	PTA18
INS - DISINS	PTA26
HAND OFF AUTO	PTA27
FORW OFF REV	PTA28
ON OFF	PTA29

SPECIAL FRAMES ON REQUEST

• **SPECIAL FRAMES: NICKEL LINE**

The auxiliary controls of Grey Line of Orion Series can be supplied with seal in Nickel.

To order Nickel Execution replace the letters "GL" with "NL":

PPRN1GL (Grey Line) > PPRN1NL (Nickel Line)

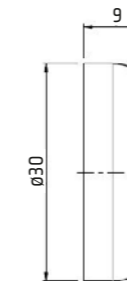

• **SPECIAL FRAMES: SHROUDED Black Line / Grey Line**

The auxiliary controls of Orion Series are available also with shrouded seal.

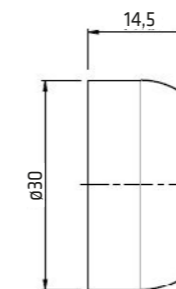

Black Line Orion Series

Grey Line Orion Series

AUXILIARY CONTROLS | ORION SERIES

AUXILIARY CONTROLS | ORION SERIES

TECHNICAL DATA | ELECTRICAL CHARACTERISTICS

CONTACT BLOCKS

EC/EN 60947-5-1 CHARACTERISTICS		PL004001-PL004002	PCW01-PCW10 / PSC01-PSC10
Rated insulation voltage Ui	V	690*	690*
Rated impulse withstand voltage Uimp	kV	4*	4*
Operating frequency	Hz	50/60*	50/60*
Rated thermal current Ith	A	16*	16*
Rated thermal current in enclosed Ithe	A	10*	10*
RATED OPERATING CURRENT Ie:			
AC15: Alternate current	V	24 60 110 230 400 440 500 690	24 60 110 240 400 440 500 690
	A	16* 12 8 6 4,5 3,5 1* 1	16* 12 5 5* 4 4 4* 2*
DC13: Direct current	V	24 48 60 110 220	24 48 60 110 250
	A	2* 1,2 0,85 0,4 0,25*	2 2* 1* 0,4 0,4*
Conditional short circuit withstand current	A	1000*	1000*
Fuse rating gG	500V	10A*	10A*
Contact insulation resistance	mΩ	<25	<25
Switching mechanism		Slow break double gap contacts	Slow break double gap contacts
Contact duty		⊕ NC contact with positive opening	⊕ NC contact with positive opening
Minimum tripping force		4N	4N
Electrical life AC15	mil. cycles	1A/1,5 - 2A/0,5 - 3A/0,25	1A/1,5 - 2A/0,5 - 3A/0,25
UL 508 CHARACTERISTICS			
General Use		10A-600V ac - 2,5A-125V dc	10A-600V ac - 2,5A-125V dc
Heavy Duty (HD) category		A600-Q600	A600-Q600

LAMP HOLDER

EC/EN 60947-5-1 CHARACTERISTICS		BUILT-IN LED
		LED PL004.L. PCW.L.-PSC.L.
Rated insulation voltage Ui	V	400
Rated operating voltage Ue	V	AC/DC 12-24
	V	AC/DC 48
	V	AC/DC 110
	V	AC 220
Max rated power	W	-
Power supply		-
Lamp fixing system		-

TECHNICAL DATA | ELECTRICAL CHARACTERISTICS

STANDARD CONFORMITY	UL - IMQ - R.I.N.A
Approvals	IEC/EN60947-5-1, UL508
Protection class	EN 60529 BLACK LINE EN 60529 GREY LINE Conforms to UL50
Material Group	EN60947-1 II
Pollution Grade	EN60947-1 3
Flammability	UL94 V0: live parts
Ambient Temperature	°C Operating: -25 +70 Storage: -30 +70
Climate Protection	IEC68 part 2-3 Hot damp IEC68 part 2-30 Unsettled Hot damp
Mechanical life:	
Mushroom operators and standard	mil./operations 3
Push buttons with colour cap	
Standard push buttons with lens cap	1
Standard rotary switches	1
Rotary switches with lens	0,5
Emergency stop push buttons with release	0,3

ASSEMBLY INSTRUCTIONS

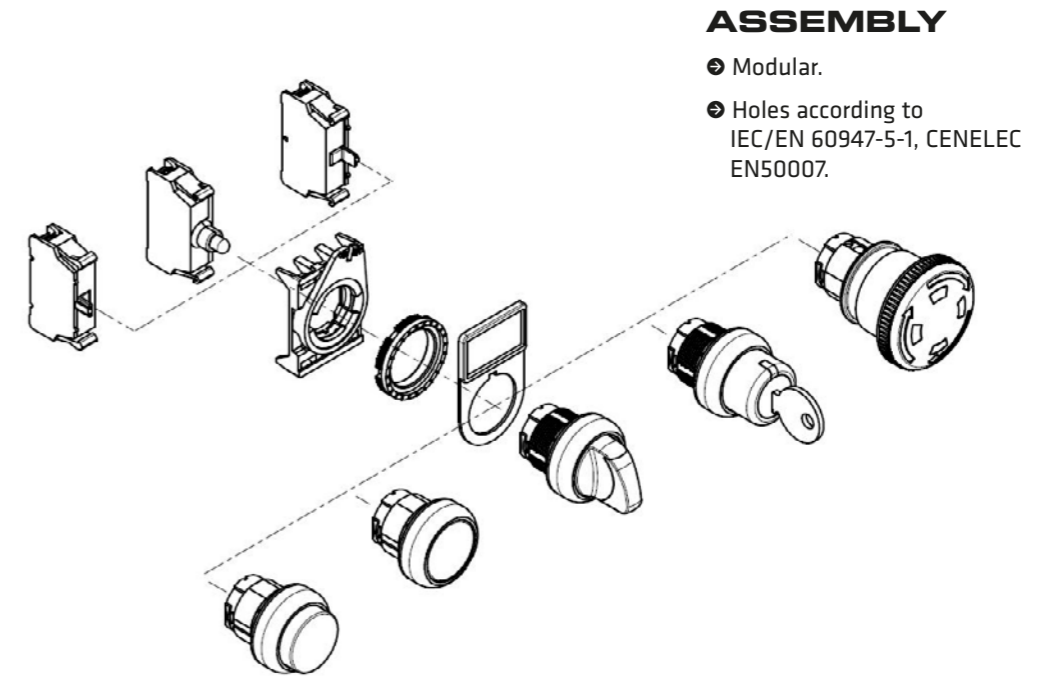

ASSEMBLY

- ⊕ Modular.
- ⊕ Holes according to IEC/EN 60947-5-1, CENELEC EN50007.

CENELEC EN50007

- ⊕ Panel thickness from 1 up to 6 mm.

- ⊕ If not required, lock nuts can be easily removed by means of a screwdriver.

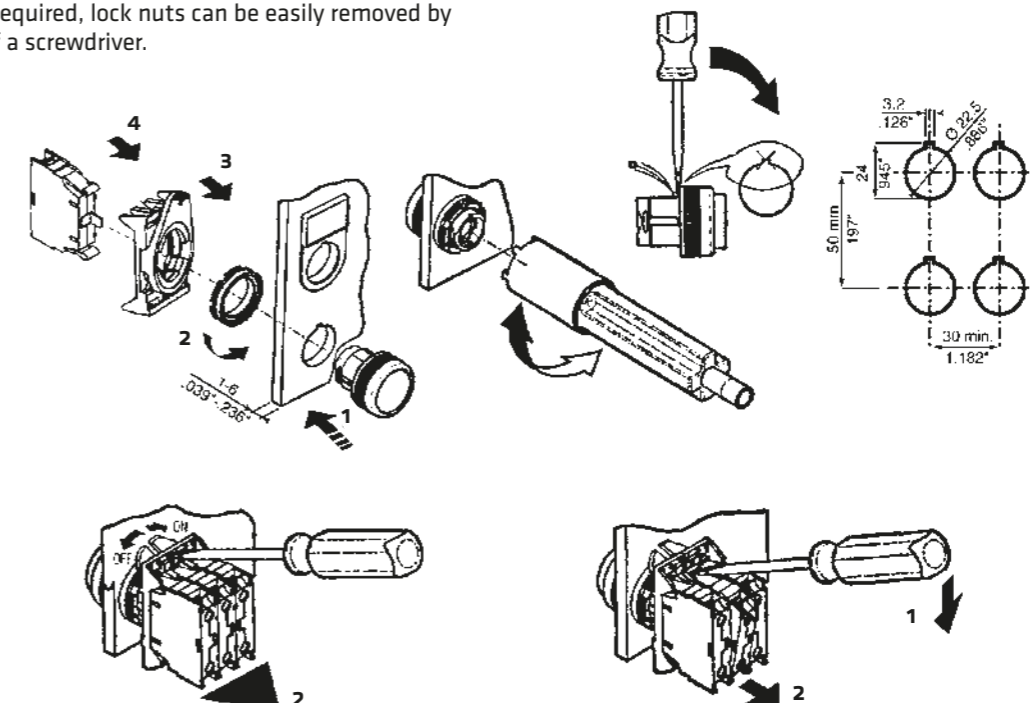



GIOVENZANA
INTERNATIONAL B.V.



GIOVENZANA
INTERNATIONAL B.V.



AUXILIARY CONTROLS
NEMA SERIES

AUXILIARY CONTROLS | NEMA SERIES

AUXILIARY CONTROLS | NEMA SERIES

PUSH BUTTONS Ø22 | WITH COLOUR CAP | NEMA 4-4X

MOMENTARY



TYPE	COLOUR INDEX	CODE	WEIGHT grams	MIN. PACK QUANTITY	SIZES
FLUSH PUSH BUTTON	■	PPRN1GL4X	30	10	
	■	PPRN2GL4X	30	10	
	■	PPRN3GL4X	30	10	
	■	PPRN4GL4X	30	10	
	■	PPRN5GL4X	30	10	
	■	PPRN8GL4X	30	10	



TYPE	COLOUR INDEX	CODE	WEIGHT grams	MIN. PACK QUANTITY	SIZES
EXTENDED PUSH BUTTON	■	PPSN1GL4X	31	10	
	■	PPSN2GL4X	31	10	
	■	PPSN3GL4X	31	10	
	■	PPSN4GL4X	31	10	
	■	PPSN5GL4X	31	10	
	■	PPSN8GL4X	31	10	

PUSH BUTTONS Ø22 | WITH LENS CAP

MOMENTARY



TYPE	COLOUR INDEX	CODE	WEIGHT grams	MIN. PACK QUANTITY	SIZES
FLUSH PUSH BUTTON	■	PPRL1GL4X	30	10	
	■	PPRL2GL4X	30	10	
	■	PPRL3GL4X	30	10	
	■	PPRL4GL4X	30	10	
	■	PPRL5GL4X	30	10	



TYPE	COLOUR INDEX	CODE	WEIGHT grams	MIN. PACK QUANTITY	SIZES
EXTENDED PUSH BUTTON	■	PPSL1GL4X	31	10	
	■	PPSL2GL4X	31	10	
	■	PPSL3GL4X	31	10	
	■	PPSL4GL4X	31	10	
	■	PPSL5GL4X	31	10	

MULTIFUNCTION PUSH BUTTONS Ø22 | NOT LIGHT | NEMA 4-4X



TYPE	COLOUR INDEX	CODE	WEIGHT grams	MIN. PACK QUANTITY	SIZES
DUAL PUSH BUTTON	■	PPDNGL4X	38	10	



TYPE	COLOUR INDEX	CODE	WEIGHT grams	MIN. PACK QUANTITY	SIZES
EXTENDED DUAL PUSH BUTTON	■	PPDNSGL4X	38	10	



TYPE	COLOUR INDEX	CODE	WEIGHT grams	MIN. PACK QUANTITY	SIZES
MULTIFUNCTION PUSH BUTTON	■	PPMNSGL4X	40	10	

MULTIFUNCTION PUSH BUTTONS Ø22 | LIGHT | NEMA 4-4X



TYPE	COLOUR INDEX	CODE	WEIGHT grams	MIN. PACK QUANTITY	SIZES
DUAL PUSH BUTTON	■	PPDLGL4X	38	10	
	■	PPDLGL4X.1	38	10	



TYPE	COLOUR INDEX	CODE	WEIGHT grams	MIN. PACK QUANTITY	SIZES
EXTENDED DUAL PUSH BUTTON	■	PPDLSGL4X	38	10	

AUXILIARY CONTROLS | NEMA SERIES

AUXILIARY CONTROLS | NEMA SERIES

EMERGENCY PUSH BUTTONS Ø22 | EN ISO 13850 | NEMA 4-4X

	TYPE	COLOUR INDEX	CODE	WEIGHT grams	MIN. PACK QUANTITY	SIZES
	MUSHROOM OPERATOR Ø30 TWIST TO RELEASE	■	PPFN1R3N4X	42	10	

	TYPE	COLOUR INDEX	CODE	WEIGHT grams	MIN. PACK QUANTITY	SIZES
	MUSHROOM OPERATOR WITH VISION Ø30 TWIST TO RELEASE	■	PPFN1R3S4X	44	10	

EMERGENCY PUSH BUTTONS Ø40 | EN ISO 13850 | NEMA 4-4X

	TYPE	COLOUR INDEX	CODE	WEIGHT grams	MIN. PACK QUANTITY	SIZES
	MUSHROOM OPERATOR Ø40 TWIST TO RELEASE	■	PPFN1R4N4X	44	10	

	TYPE	COLOUR INDEX	CODE	WEIGHT grams	MIN. PACK QUANTITY	SIZES
	MUSHROOM OPERATOR WITH VISION Ø40 TWIST TO RELEASE	■	PPFN1R4S4X	46	10	

	TYPE	COLOUR INDEX	CODE	WEIGHT grams	MIN. PACK QUANTITY	SIZES
	MUSHROOM OPERATOR Ø40 WITH KEY RELEASE	■	PPFN1C4NX4X (not EN ISO 13850)	76	10	

	TYPE	COLOUR INDEX	CODE	WEIGHT grams	MIN. PACK QUANTITY	SIZES
	MUSHROOM OPERATOR Ø40 PUSH-PULL	■	PPFN1P4N4X	44	10	

	TYPE	COLOUR INDEX	CODE	WEIGHT grams	MIN. PACK QUANTITY	SIZES
	MUSHROOM OPERATOR Ø40 PUSH-PULL WITH VISION	■	PPFN1P4S4X	46	10	

TECHNICAL NOTES

- All operators comply with the relevant European and American standard.
- EN ISO 13850: Machine safety - Emergency stop operators, functional characteristics - Design guidelines.
- IEC/EN6097-5-1.
- Comply with the standard IEC/EN60204-1: Machine safety - Machine electrical circuits - General guidelines.
- The push buttons are designed with a load charge mechanism to ensure a reliable operation and stoppage, or blockage, in the activate position. The combination with positive switching NC contacts and the presence of the "status" indicator on some models, guarantee a high degree of reliability and effectiveness.

ROTARY SWITCHES Ø22 | NEMA 4-4X

WITH OPERATOR

WITH LIGHT OPERATOR

WITH KEY



POSITION	COLOUR INDEX	CODE	COLOUR INDEX	CODE	KEY REMOVAL			CODE
					L	O	R	
 90°	■	PSMB1D0GL4X	■	PSML1D0GL4X		*		PSCR8D0CGL4X
	■	PSMB2D0GL4X	■	PSML2D0GL4X			*	PSCR8D0EGL4X
	■	PSMB3D0GL4X	■	PSML3D0GL4X			*	PSCR8D0NGL4X
	■	PSMB4D0GL4X	■	PSML4D0GL4X			*	
	■	PSMB5D0GL4X	■	PSML5D0GL4X			*	
 45°	■	PSMB1D1GL4X	■	PSML1D1GL4X		*		PSCR8D1CGL4X
	■	PSMB2D1GL4X	■	PSML2D1GL4X			*	PSCR8D1EGL4X
	■	PSMB3D1GL4X	■	PSML3D1GL4X			*	PSCR8D1NGL4X
	■	PSMB4D1GL4X	■	PSML4D1GL4X			*	
	■	PSMB5D1GL4X	■	PSML5D1GL4X			*	
 45°	■	PSMB1D2GL4X	■	PSML1D2GL4X			*	PSCR8D2CGL4X
	■	PSMB2D2GL4X	■	PSML2D2GL4X			*	
	■	PSMB3D2GL4X	■	PSML3D2GL4X			*	
	■	PSMB4D2GL4X	■	PSML4D2GL4X			*	
	■	PSMB5D2GL4X	■	PSML5D2GL4X			*	
 45°	■	PSMB1T0GL4X	■	PSML1T0GL4X	*	*	*	PSCR8T0CGL4X
	■	PSMB2T0GL4X	■	PSML2T0GL4X	*	*	*	PSCR8T0AGL4X
	■	PSMB3T0GL4X	■	PSML3T0GL4X	*	*	*	PSCR8T0EGL4X
	■	PSMB4T0GL4X	■	PSML4T0GL4X	*	*	*	PSCR8T0GGL4X
	■	PSMB5T0GL4X	■	PSML5T0GL4X	*	*	*	PSCR8T0HGL4X
 45°	■	PSMB1T3GL4X	■	PSML1T3GL4X			*	PSCR8T3CGL4XL
	■	PSMB2T3GL4X	■	PSML2T3GL4X			*	
	■	PSMB3T3GL4X	■	PSML3T3GL4X			*	
	■	PSMB4T3GL4X	■	PSML4T3GL4X			*	
	■	PSMB5T3GL4X	■	PSML5T3GL4X			*	
 45°	■	PSMB1T2GL4X	■	PSML1T2GL4X		*		PSCR8T2CGL4X
	■	PSMB2T2GL4X	■	PSML2T2GL4X			*	PSCR8T2AGL4X
	■	PSMB3T2GL4X	■	PSML3T2GL4X			*	PSCR8T2HGL4X
	■	PSMB4T2GL4X	■	PSML4T2GL4X			*	
	■	PSMB5T2GL4X	■	PSML5T2GL4X			*	
 45°	■	PSMB1T1GL4X	■	PSML1T1GL4X		*		PSCR8T1CGL4X
	■	PSMB2T1GL4X	■	PSML2T1GL4X			*	PSCR8T1EGL4X
	■	PSMB3T1GL4X	■	PSML3T1GL4X			*	PSCR8T1NGL4X
	■	PSMB4T1GL4X	■	PSML4T1GL4X			*	
	■	PSMB5T1GL4X	■	PSML5T1GL4X			*	

1 For standard rotary switches suitable to operate a central contact, replace the letter "B" with the letter "C": PSMB1C0GL4X or PSMB1C1GL4X
2 For rotary switches with Left - Right operating angles replace the letters "DO" with "SD": PSMB1SD0GL4X or PSMB1SD1GL4X

* Key removable position

OPERATOR CAPS Ø22 | NEMA 4-4X

MOMENTARY FLUSH PUSH BUTTONS



SYMBOL	COLOUR	CODE	SYMBOL	COLOUR	CODE
	■	PPRN2GL4X/I		■	PPRN2GL4X/ON
	■	PPRN1GL4X/O		■	PPRN1GL4X/OFF
	■	PPRN2GL4X/II		■	PPRN5GL4X/F
	■	PPRN2GL4X/START		■	PPRN8GL4X/F
	■	PPRN1GL4X/STOP			

Available others symbols on request, also in different languages and colours.

ACCESSORIES | NEMA 4-4X

CENTRAL CONTACT OPERATION



DESCRIPTION	CODE
NEMA 4X SERIES	11708555

KEY FIXING BULB EXTRACTOR



CODE
PCF

CONTACTS SUPPORT



DESCRIPTION	CODE	DESCRIPTION	CODE
TO CONTACT ELEMENTS PL, PCW, PSC	PPELN8	TO FIVE CONTACT ELEMENTS PL, PCW, PSC	PPELN8-5

FASTON CONNECTORS AND FOR PCB



DESCRIPTION	CODE	DESCRIPTION	CODE
FASTON 6,3x0,8	11708341	PCB	11708235

TO SCREW CONTACTS PL

SPECIAL FRAMES ON REQUEST

• **SPECIAL FRAMES: SHROUDED NEMA**

The auxiliary controls of NEMA Series are available also with shrouded seal.

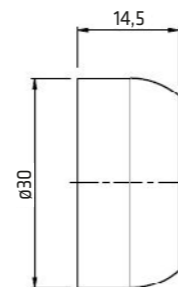

NEMA Series

TECHNICAL DATA | ELECTRICAL CHARACTERISTICS

CONTACT BLOCKS

EC/EN 60947-5-1 CHARACTERISTICS		PL004001-PL004002	PCW01-PCW10 / PSC01-PSC10
Rated insulation voltage Ui	V	690*	690*
Rated impulse withstand voltage Uimp	kV	4*	4*
Operating frequency	Hz	50/60*	50/60*
Rated thermal current Ith	A	16*	16*
Rated thermal current in enclosed Ithe	A	10*	10*
RATED OPERATING CURRENT Ie:		PL004001-PL004002	PCW01-PCW10 / PSC01-PSC10
AC15: Alternate current	V	24 60 110 230 400 440 500 690	24 60 110 240 400 440 500 690
	A	16* 12 8 6 4,5 3,5 1* 1	16* 12 5 5* 4 4 4* 2*
DC13: Direct current	V	24 48 60 110 220	24 48 60 110 250
	A	2* 1,2 0,85 0,4 0,25*	2 2* 1* 0,4 0,4*
Conditional short circuit withstand current	A	1000*	1000*
Fuse rating gG	500V	10A*	10A*
Contact insulation resistance	mΩ	<25	<25
Switching mechanism		Slow break double gap contacts	Slow break double gap contacts
Contact duty		⊕ NC contact with positive opening	⊕ NC contact with positive opening
Minimum tripping force		4N	4N
Electrical life AC15	mil. cycles	1A/1,5 - 2A/0,5 - 3A/0,25	1A/1,5 - 2A/0,5 - 3A/0,25
UL 508 CHARACTERISTICS		PL004001-PL004002	PCW01-PCW10 / PSC01-PSC10
General Use		10A-600V ac - 2,5A-125V dc	10A-600V ac - 2,5A-125V dc
Heavy Duty (HD) category		A600-Q600	A600-Q600

LAMP HOLDER

EC/EN 60947-5-1 CHARACTERISTICS		BUILT-IN LED
Rated insulation voltage Ui	V	400
Rated operating voltage Ue	V	AC/DC 12-24
	V	AC/DC 48
	V	AC/DC 110
	V	AC 220
Max rated power	W	-
Power supply		-
Lamp fixing system		-

TECHNICAL DATA | ELECTRICAL CHARACTERISTICS

STANDARD CONFORMITY	UL
Approvals	UL508, CSA 22.2
Protection class	Buttons and switches, Multifunction push button
	Emergency push buttons EN ISO 13850
	Type 1-4-4X
Material Group	II
Pollution Grade	3
Ambient Temperature	Operating: -25 +70
	Storage: -30 +70
Climate Protection	Hot damp
	Unsettled Hot damp
Mechanical life:	
Push buttons with colour cap	3
Standard push buttons with lens cap	1
Standard rotary switches	1
Rotary switches with lens	0,5
Emergency stop push buttons with release	0,3



GIOVENZANA
INTERNATIONAL B.V.



GIOVENZANA
INTERNATIONAL B.V.



**POTENTIOMETERS &
DOUBLE SOCKETS**

POTENTIOMETERS

- Full Potentiometer enclosed in a single block standard 22 mm diameter, plug & play, ready to be fixed on an electrical panel.
- The potentiometer is provided in different versions depending on the ohmic resistance required with a 3-poles terminal board with an easy push-in type spring-operated connection. This technology allows a very handy quick wiring procedure, since the wire just needs to be inserted into the appropriate hole in order to be secured and to establish the electrical connection.



Marking



BLACK LINE	NICKEL LINE
PPPTNBL1K	PPPTNNL1K
PPPTNBL2K5	PPPTNNL2K5
PPPTNBL5K	PPPTNNL5K
PPPTNBL10K	PPPTNNL10K
PPPTNBL50K	PPPTNNL50K
PPPTNBL100K	PPPTNNL100K
PPPTNBL500K	PPPTNNL500K

TECHNICAL DATA

Protection class	IP67 (IEC 60529) IP69K (ISO 20653)
Ambient temperature	-40°C +90°C
Mechanical endurance	75000 operations cycles
Resistance range	Linear 1kΩ k to 0.5MΩ
Tolerance	Linear: 10%
Linearity (typical)	± 5 % independent
End resistance	4Ω maximum each end
Power rating	0.5 W at 70°C - 0 W at 120°C
Effective rotation	270° ± 10° without rotary switch 240° ± 10° with rotary switch
Contact resistance variation	1,5% of total resistance - 3% of total resistance
Max continuous working voltage	350 VAC across end terminals, but within power rating
Electrical scheme	
Ohmic resistance	001K 1000 Ω 02K5 2500 Ω 005K 5000 Ω 010K 10,000 Ω 050K 50,000 Ω 100K 100,000 Ω 500K 500,000 Ω
Standard reference	IEC 60947-1, IEC 60947-5-1, IEC 60204-1, EN 60947-1, EN 60947-5-1, EN 60204-1
Directive reference	Low voltage directive 2006/95/EC, Machinery directive 2006/42/EC and EMC directive 2004/108/EC.

DOUBLE SOCKETS

RJ45 DOUBLE SOCKET

- RJ45 connector in a standard 22 mm diameter block "plug & play".
- It makes possible to bring the Ethernet networks through an electrical panel without opening it.
- The protection rubber cap integrated remains joined to the device to avoid being lost and prevents any water or dirt from penetrating inside.



BLACK LINE	NICKEL LINE
PP2RJ45BL	PP2RJ45NL

Marking

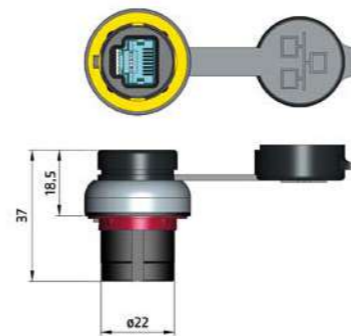

TECHNICAL DATA

Connection	RJ45
Protection degree	IP67 (IEC 60529)
Ambient temperature	-25°C +75°C
Standard reference	IEC 60947-1, IEC 60947-5-1, IEC 60204-1, EN 60947-1, EN 60947-5-1, EN 60204-1
Directive reference	Low voltage directive 2006/95/EC, Machinery directive 2006/42/EC and EMC directive 2004/108/EC.

USB 2.0 & 3.0 DOUBLE SOCKETS

- USB socket in a standard 22 mm diameter block "plug & play".
- It makes possible to transfer data and electricity through an electrical panel without opening it.
- The protection rubber cap integrated remains joined to the device to avoid being lost and prevents any water or dirt from penetrating inside.



BLACK LINE	NICKEL LINE
PP2USB20BL	PP2USB20NL
PP2USB30BL	PP2USB30NL

Marking

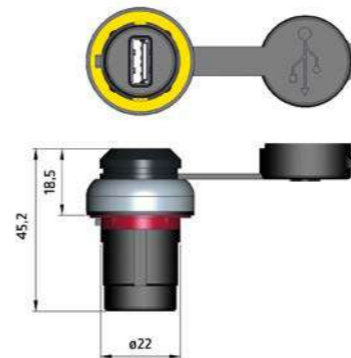

TECHNICAL DATA

Connection	USB 2.0 - USB 3.0
Protection degree	IP67 (IEC 60529)
Ambient temperature	-25°C +75°C
Standard reference	IEC 60947-1, IEC 60947-5-1, IEC 60204-1, EN 60947-1, EN 60947-5-1, EN 60204-1
Directive reference	Low voltage directive 2006/95/EC, Machinery directive 2006/42/EC and EMC directive 2004/108/EC.

USB 2.0

The USB 2.0 socket takes advantage of the standard data transfer speed. It's the most frequently used on the market and furthermore this option offers the best value for money.

USB 3.0

The USB 3.0 is the latest generation of data transfer on the market. This solution offers the maximum data transfer speed and the socket is backward compatible with previous USB connectors.



GIOVENZANA
INTERNATIONAL B.V.



GIOVENZANA
INTERNATIONAL B.V.



FOOT SWITCHES
SINGLE & DOUBLE



Single or double foot switches thermoplastic type with the EN ISO 13850 emergency stop option.
Available with electric or pneumatic controls.

IP65

SAFETY FOOT SWITCHES

Application

The safety foot switches are used as control switches of machines and plants when the operator must have his hands free to perform other functions.

Design and mode of operation

The safety foot switches in thermoplastic material are equipped with a shield to protect against accidental and unintentional actuation due to tool drop or unwanted trampling. In addition they are equipped with non-slip rubber feet and mechanical lock mounted in the pedal to prevent it from operating in the case the foot has not been fully positioned above the pedal.

The version without blocking and without foot protection cap is preferred when the main function is to stop the machine.

The electric foot switches can be equipped with a mushroom button as an emergency to interrupt the circuit even in the case of a actuated pedal. The electric contact exchange occurs when the pedal is completely lowered. The protection degree for single foot switches is IP65, while for double and with emergency mushroom is IP54. All foot switches are compliant with the Machinery Directive and are CE-marked.



GENERAL CHARACTERISTICS

Comply with		IEC/EN60947-5-1							
Rated insulation voltage U_i	V	690 (pollution class 3)							
Rated impulse withstand voltage U_{imp}	kV	4							
Operating frequency	Hz	50/60							
Rated thermal current I_{th}	A	10							
Rated operating current I_e :									
AC-15 alternate current	V	24	60	120	240	400	440	500	690
	A	16	12	8	6	4,5	3,5	1	1
DC-13 continuous current	V	24	48	60	110	220			
	A	2	1,2	0,85	0,4	0,25			
Conditional short circuit withstand		1000A - 10A-500V class gG fuses							
Contact impedance	m Ω	≤ 25							
Contact type		Slow break double gap contacts							
Positive opening		NC contact with positive opening							
Electric shock protection	IEC 536	Class II							
Protection rating	IEC 529	IP65							
Ambient temperature	$^{\circ}C$	Operating: -25 +70							
	$^{\circ}C$	Storage: -30 +70							
Cable entry		pre-broken hole 16,5 - M20 (with safety)							



PRODUCT	DESCRIPTION	CONTACTS	CODE	MIN. PACK	WEIGHT
	Foot switch with trigger mechanism requiring positive action to allow pedal operation. Colour: PANTONE 102C	Slow break		Quantity	grams
		1NO	IP7007	1	1.400
		2NO	IP7008	1	1.400
		1NO+1NC	IP7007I	1	1.400
		1NO	IP7009	1	1.400
		Two speeds 1NO+1NO	IP7015	1	1.400

This product is also available in different colors:

Colour:
 RAL 7035



Colour:
 RAL 5010



DIMENSIONAL DRAWINGS

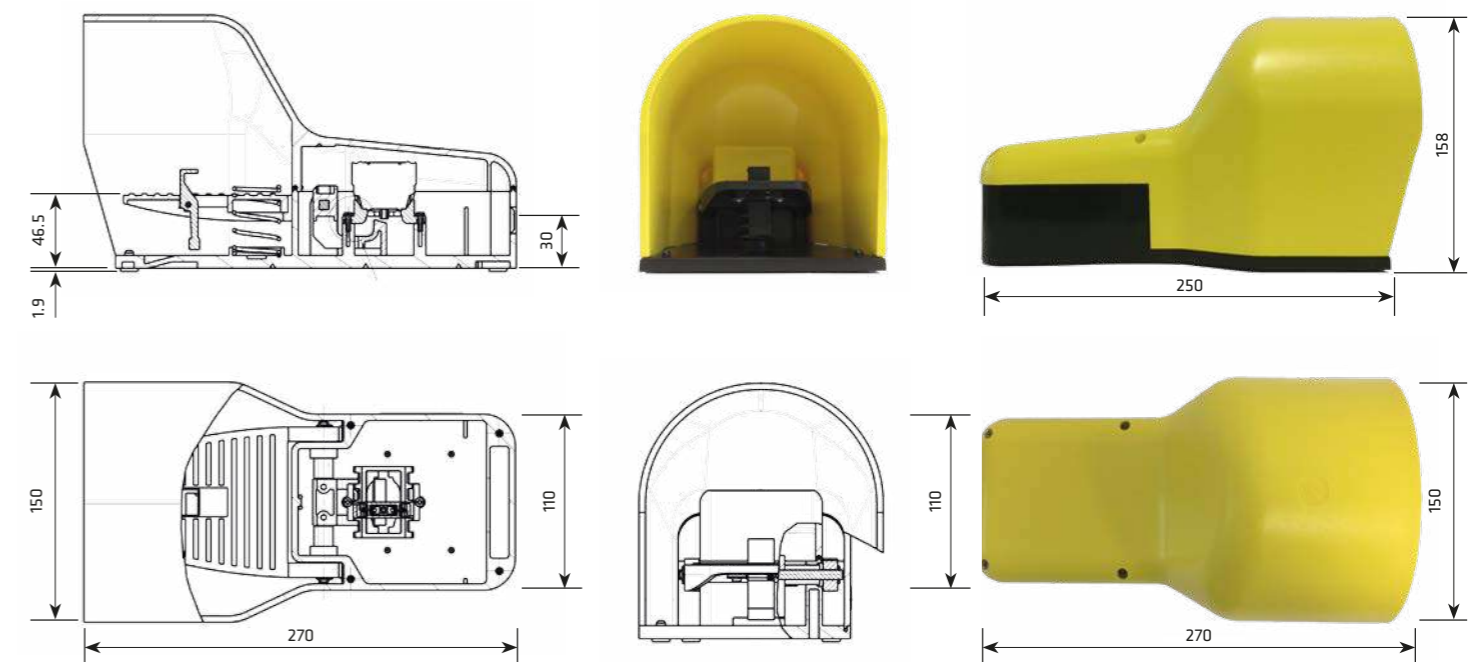



FOOT SWITCHES SERIES | SINGLE FOOT SWITCHES SERIES

FOOT SWITCHES SERIES | SINGLE FOOT SWITCHES SERIES

Single foot switches thermoplastic material.
Available with electric or pneumatic controls.

IP65

SINGLE FOOT SWITCHES

GENERAL CHARACTERISTICS

Application

The foot switches are used to start and stop operations and production processes on machinery and plants, where manual operation is impossible. Different foot switches versions are available depending on the ambient conditions and the mechanical behaviour. Applications include use on packaging machines, storage and transport technology as well as on textile machines.

Configurations

- Electrical version with NO contacts, single, double speed and with NC contacts with positive opening.
- Pneumatic version with 5 and 2 ways valves.
- With hooking device to keep the pedal lowered and the contact activated until the release is made by the front of the foot.
- The shaft with knob or handle on the tubular is available in the version with an emergency mushroom to carry the foot switch comfortably.

Comply with		IEC/EN60947-5-1
Rated insulation voltage Ui	V	690 (pollution class 3)
Rated impulse withstand voltage Uimp	kV	4
Operating frequency	Hz	50/60
Rated thermal current Ith	A	10
Rated operating current Ie:		
AC-15 alternate current	V	24 60 120 240 400 440 500 690
	A	16 12 8 6 4,5 3,5 1 1
DC-13 continuous current	V	24 48 60 110 220
	A	2 1,2 0,85 0,4 0,25
Conditional short circuit withstand		1000A - 10A-500V class gG fuses
Contact impedance	m Ω	≤25
Contact type		Slow break double gap contacts
Positive opening		NC contact with positive opening
Electric shock protection	IEC 536	Class II
Protection rating	IEC 529	IP65
Ambient temperature	°C	Operating: -25 +70
	°C	Storage: -30 +70
Cable entry		pre-broken hole 16,5 - M20 (with safety)

DIMENSIONAL DRAWINGS

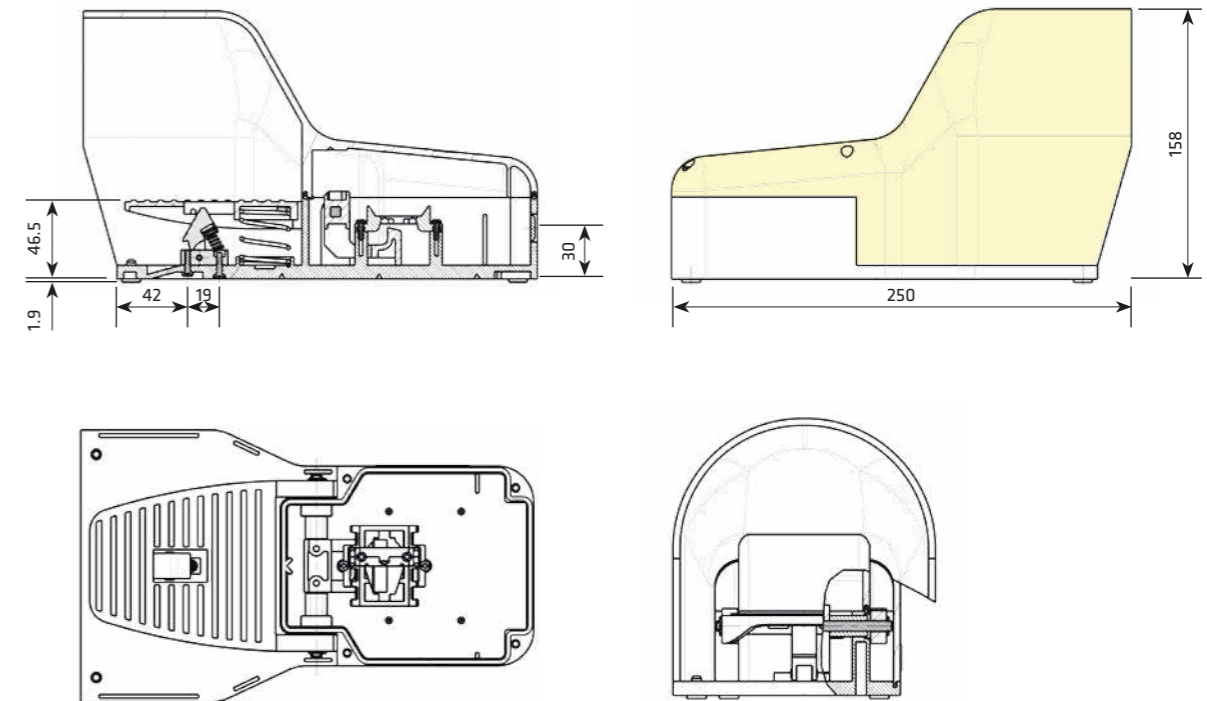

PRODUCT	DESCRIPTION	CONTACTS	CODE	MIN. PACK	WEIGHT
	Foot switch with pedal latching device and without trigger mechanism.	Slow break		Quantity	grams
		1NO	IP7011	1	1.400
	Colour: PANTONE 102C				

PRODUCT	DESCRIPTION	CONTACTS	CODE	MIN. PACK	WEIGHT
	Foot switch without rest position trigger mechanism.	Slow break		Quantity	grams
		1NO+1NC	IP7006I	1	1.300
	Foot switch with pedal latching device and without trigger mechanism.	Slow break		Quantity	grams
		1NO+1NC	IP7035	1	1.300
	Colour: RAL 3020				

DIMENSIONAL DRAWINGS

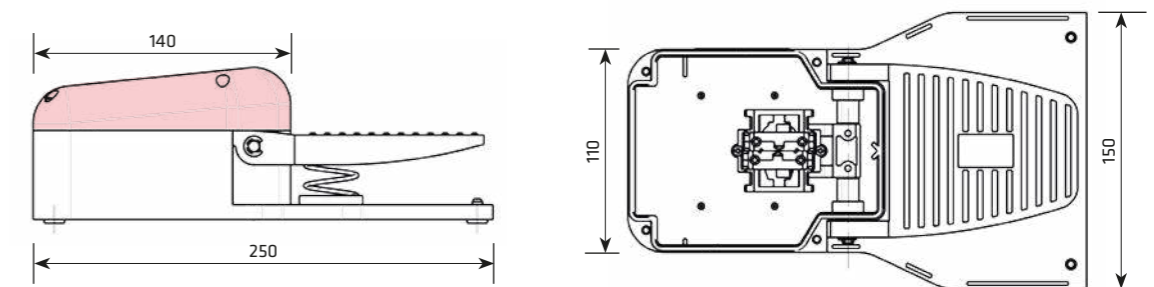





FOOT SWITCHES SERIES | SINGLE FOOT SWITCHES SERIES





FOOT SWITCHES SERIES | SINGLE FOOT SWITCHES SERIES

Single foot switches thermoplastic material.
Available with electric or pneumatic controls.

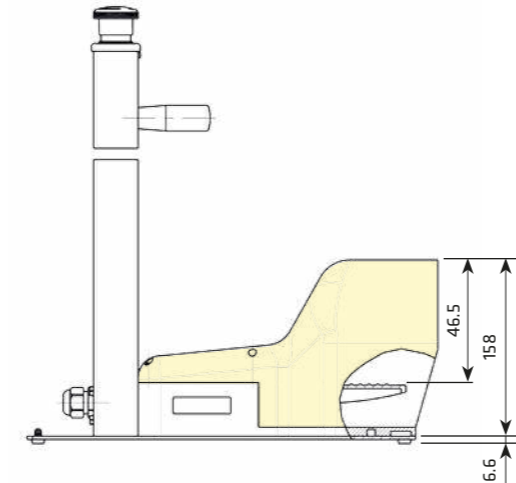
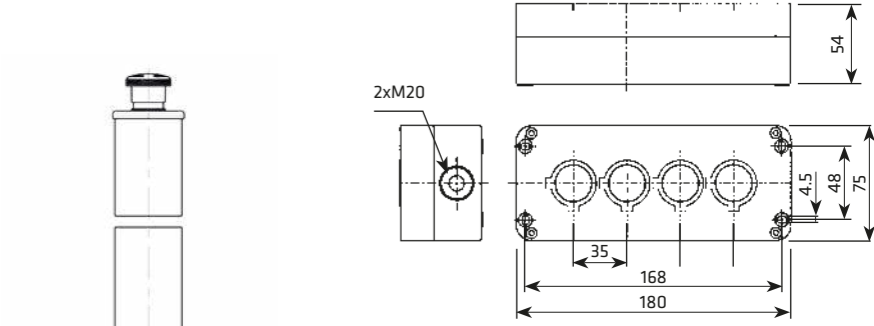
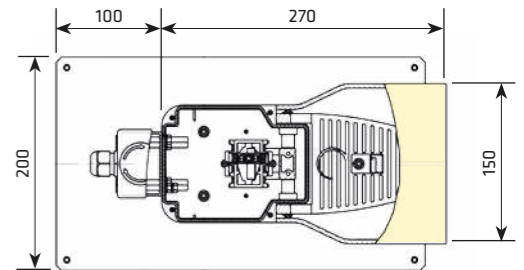
IP54 □

SINGLE FOOT SWITCHES	DESCRIPTION	CONTACTS	CODE	MIN. PACK	WEIGHT
	Foot switch with trigger mechanism and ENI ISO 13850 emergency stop. Colour: ■ PANTONE 102C	Slow break		Quantity	grams
		1NO	IP7007EM	1	3.900
		Two speeds 1NO + 1NO	IP7015EM	1	3.910
	ON REQUEST				
	IP7026 with PQ01 station 4 holes with EN ISO 13850 emergency stop.				

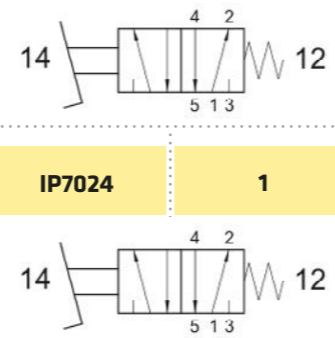
DIMENSIONAL DRAWINGS	
	
	

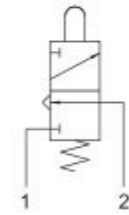
PNEUMATIC SINGLE FOOT SWITCHES	DESCRIPTION	CONTACTS	CODE	MIN. PACK	WEIGHT
	Foot switch pneumatic with trigger mechanism. Colour: ■ PANTONE 102C	Slow break		Quantity	grams
		With 1/4" 5 ways valve	IP7023	1	1.600
	Foot switch Pneumatic with pedal latching device and without trigger mechanism. Colour: ■ PANTONE 102C	With 1/4" 5 ways valve	IP7024	1	1.600
					
	Foot switch Pneumatic with trigger mechanism. Colour: ■ PANTONE 102C	With 3/2" 2 ways valve	IP7032	1	1.600
					

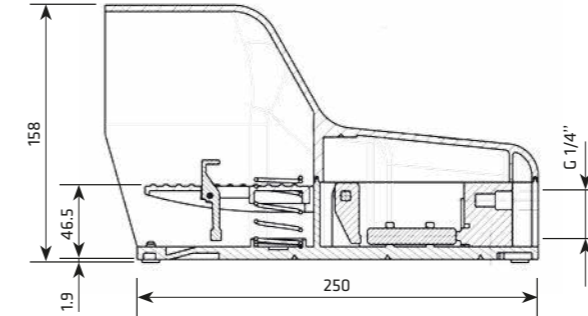
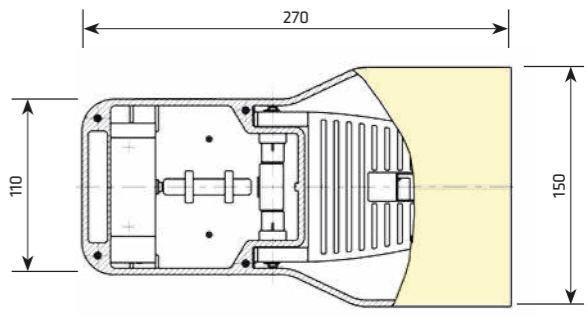
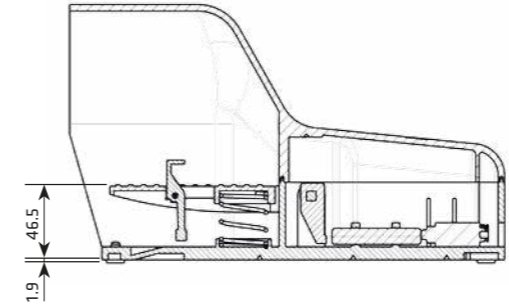
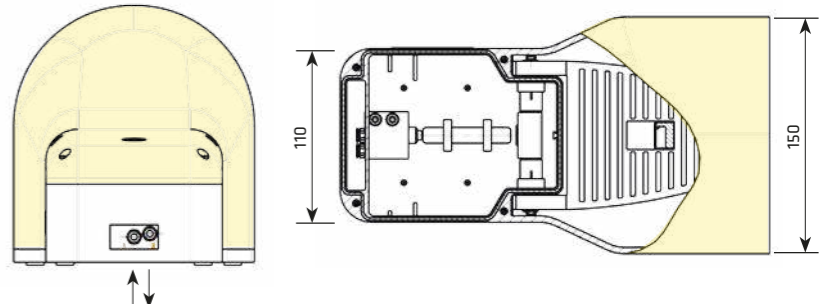
DIMENSIONAL DRAWINGS	
	
	

Working pressure 2:10 bar.



FOOT SWITCHES SERIES | DOUBLE FOOT SWITCHES SERIES

FOOT SWITCHES SERIES | DOUBLE FOOT SWITCHES SERIES

Double foot switches thermoplastic type with EN ISO 418 emergency stop option.

IP54

DOUBLE FOOT SWITCHES WITH EN 418 EMERGENCY STOP

DESCRIPTION	CONTACTS	CODE	MIN. PACK	WEIGHT
Foot switch with trigger mechanism requiring positive action to allow pedal operation. Colour: ■ PANTONE 102C	Slow break		Quantity	grams
	1NO + 1NO	IP7018EM	1	5.300
	2NO + 2NO	IP7019EM	1	5.300

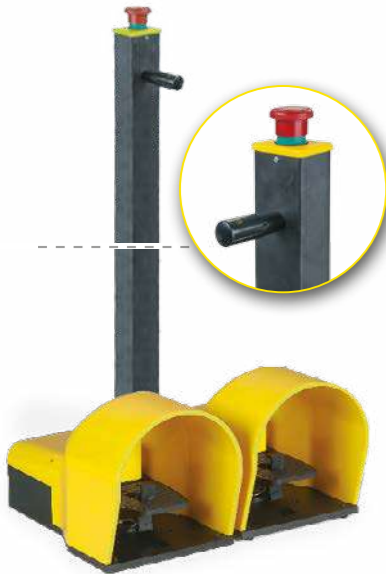

ON REQUEST

Available double foot switch IP7027 with PQ04 station 4 holes with EN ISO 13850 emergency stop.

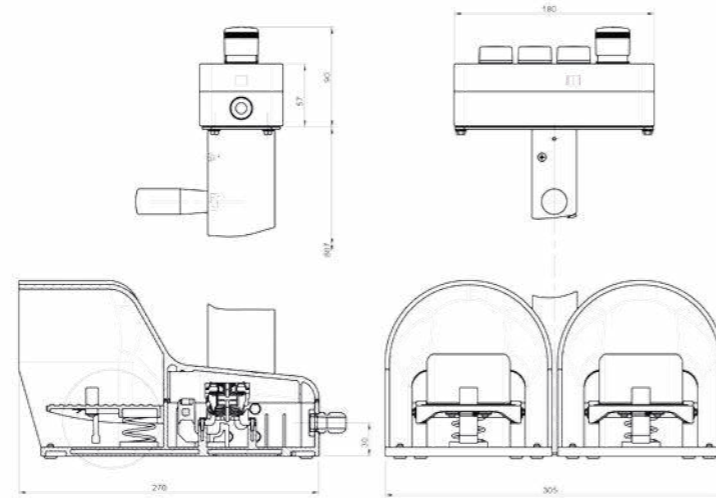

DIMENSIONAL DRAWINGS

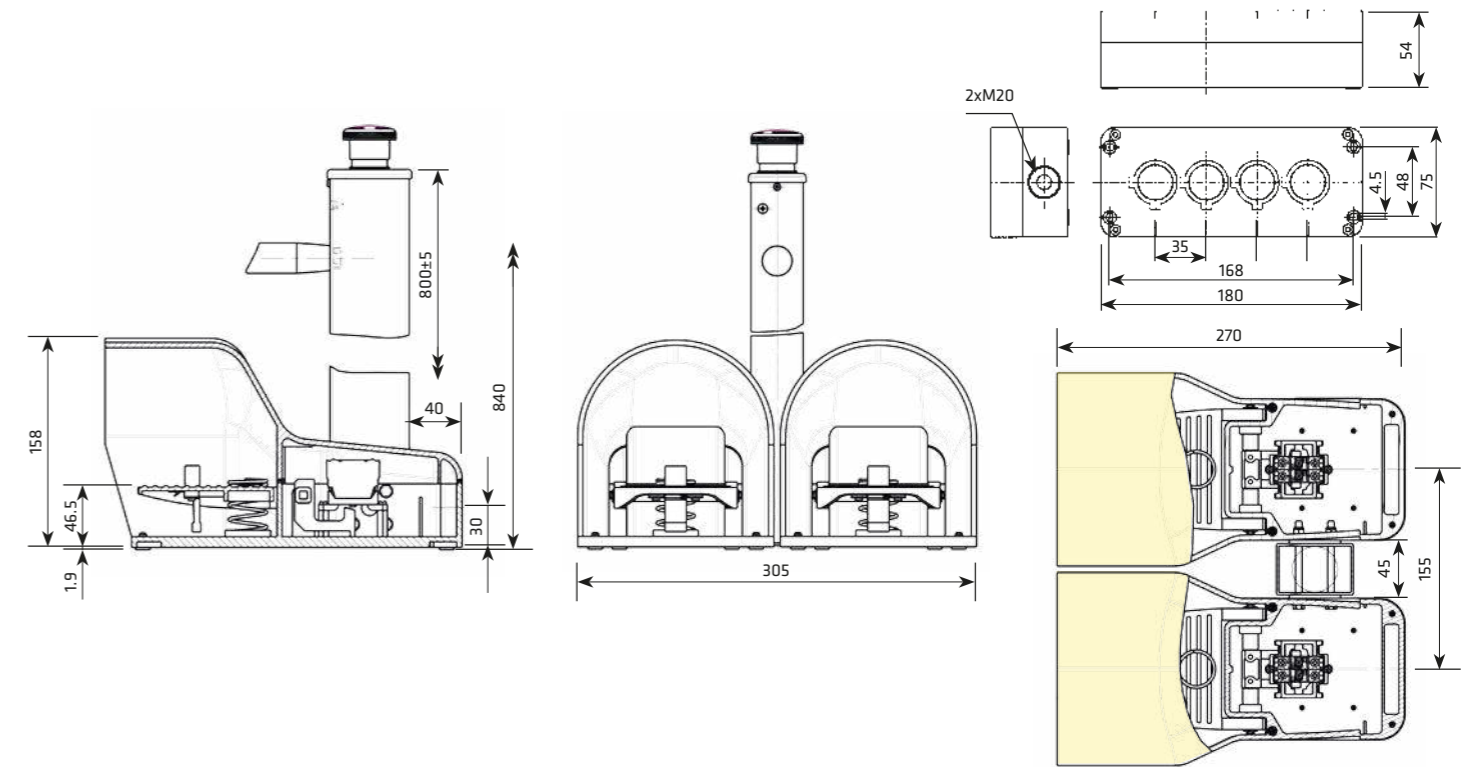

Double foot switches thermoplastic type with EN ISO 13850.

IP54

DOUBLE FOOT SWITCHES

DESCRIPTION	CONTACTS	CODE	MIN. PACK	WEIGHT
Foot switch with trigger mechanism requiring positive action to allow pedal operation. Colour: ■ PANTONE 102C	Slow break		Quantity	grams
	1NO + 1NO	IP7018	1	3.100
	2NO + 2NO	IP7019	1	3.100



DIMENSIONAL DRAWINGS

