



SGP40-12

Valve-regulated lead-acid battery

GENERAL PURPOSE SERIES

Characteristics

Nominal voltage	12V (6 cells per unit)	
Nominal capacity at 10 hours rate/10.8V (25°C)	40Ah	
Capacity (25°C)	20 Hours rate/10.8V	42.4Ah
	5 Hours rate/10.8V	34.1Ah
Terminal type	T5	
Torque	5.1±0.6N.m	
Approx. internal resistance (25°C)	9.0mΩ	
Dimensions	Length	197±2mm (7.76inch)
	Width	165±2mm (6.50inch)
	Height	170±2mm (6.69inch)
	Total height	170±2mm (6.69inch)
Design Life (stand-by)	JIS at 25°C	10 years
	Eurobat at 20°C	10/12 years
Weight	12.50kg (30.40lbs)±3%	
Nominal operating temperature	25°C±3 (77±5°F)	
Operating temperature range	Discharge	-15°C~50°C (5°F~122°F)
	Charge	-10°C~50°C (14°F~122°F)
	Storage	-20°C~50°C (-4°F~122°F)
Float charging voltage at 25°C	13.5V~13.8V	
Cyclic charging voltage at 25°C	14.5V~15.0V	
Temperature compensation	Float charge	-18 mV/°C/Block
	Cycle charge	-30 mV/°C/Block
Max. charging current (A)	12A	
Max. discharge current for 5 seconds	400A	
Self discharge rate (25°C)	≤3%/month	
Battery container ABS UL94-HB	V-0 optional	

Overview

General Purpose series batteries are designed with state-of-the-art AGM (absorbent glass mat) technology, high-performance plates and electrolyte. With excellent value and characteristics, this range is suitable for all general purpose applications.

Dimensions & Terminal Type (mm)

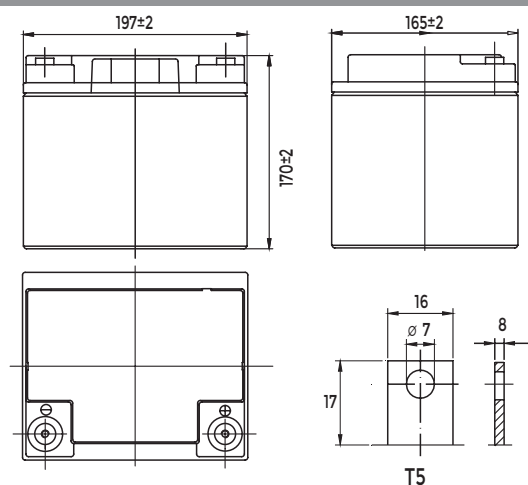

Construction

Component	Positive Plate	Negative plate	Container	Separator	Electrolyte	Safety valve	Terminal
Raw material	Lead dioxide	Lead	ABS (V-0 opt.)	AGM	Sulfuric Acid	Rubber	Copper

Constant current discharge characteristics at 25°C

(Ampere/battery)

F.V/Time	10min	15min	30min	60min	2h	3h	4h	5h	8h	10h	20h
9.60V	87.2	67.2	40.2	24.7	14.6	10.5	8.40	7.18	4.94	4.07	2.16
9.90V	84.6	65.6	39.4	24.3	14.5	10.5	8.36	7.14	4.91	4.06	2.15
10.2V	81.1	63.2	38.2	23.7	14.4	10.4	8.30	7.09	4.87	4.05	2.15
10.5V	77.6	61.0	37.3	23.0	14.2	10.3	8.24	7.04	4.84	4.03	2.13
10.8V	73.2	57.8	35.9	22.2	13.8	10.0	7.99	6.83	4.69	4.00	2.12

Constant power discharge characteristics at 25°C

(Watts/battery)

F.V/Time	10min	15min	30min	60min	2h	3h	4h	5h	8h	10h	20h
9.60V	942	738	451	282	169	124	98.8	84.9	58.6	48.6	25.9
9.90V	914	720	442	278	168	123	98.3	84.4	58.3	48.5	25.8
10.2V	876	694	428	271	167	122	97.6	83.8	57.9	48.4	25.8
10.5V	838	670	418	262	164	121	96.9	83.2	57.5	48.1	25.6
10.8V	791	635	403	254	160	118	94.0	80.7	55.8	47.8	25.4

The above characteristics represent average values and can be obtained within three charge and discharge cycles. The batteries must be fully charged before testing. The data in this document is subject to change without notice and become contractual only after written confirmation. Please contact SICBAT for the latest available version.

Discharge characteristics (25°C)

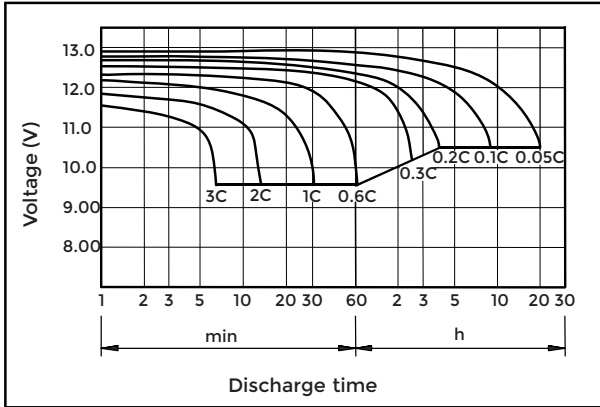

Charging characteristics (25°C)

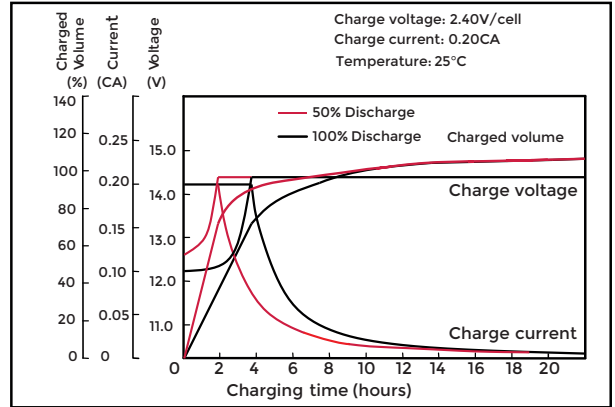

Temperature effects on capacity

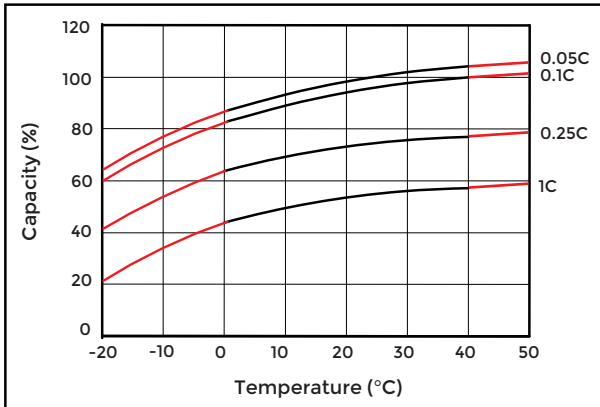

Self-discharge characteristics

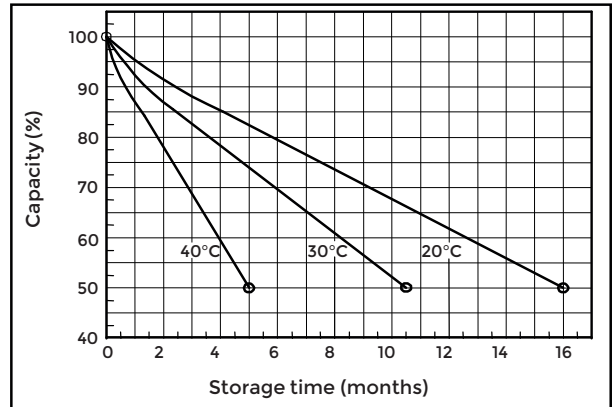

Floating life on temperature

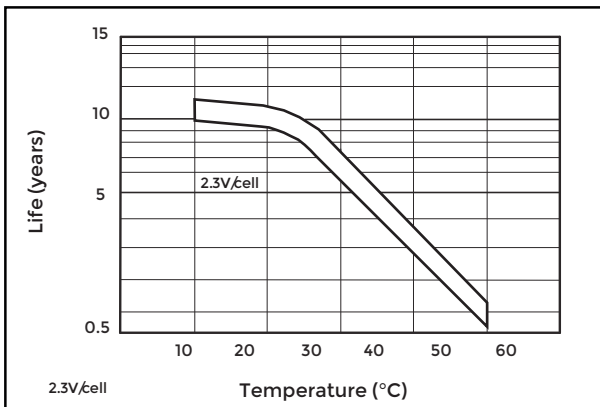

Cycle life on D.O.D (25°C)

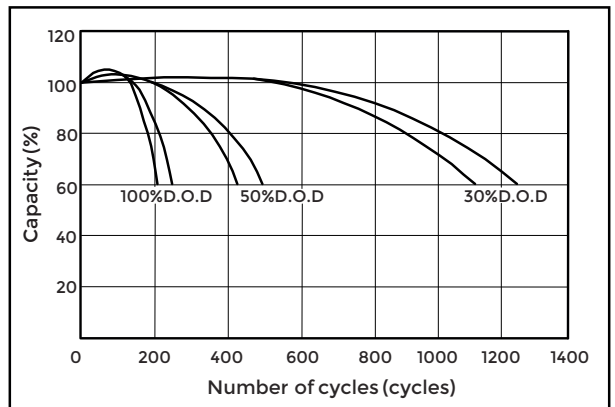

Relationship for OCV and capacity (25°C)

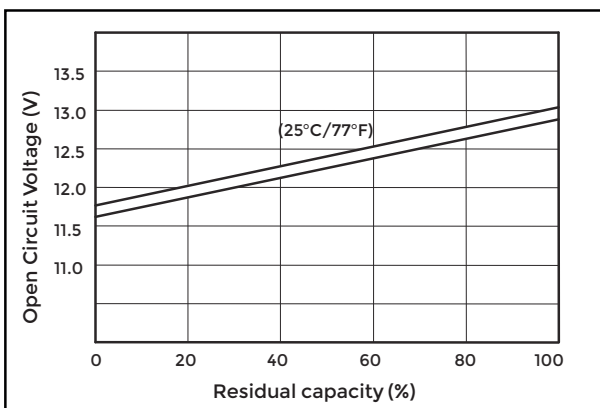

Charging voltage VS temperature

